



Fourth quarter 2023

Results and investor update

Important information

Forward Looking Statements: This presentation contains statements that constitute “Forward looking statements,” including but not limited to management’s outlook for UBS’s financial performance, statements relating to the anticipated effect of transactions and strategic initiatives on UBS’s business and future development and goals or intentions to achieve climate, sustainability and other social objectives. While these Forward looking statements represent UBS’s judgments, expectations and objectives concerning the matters described, a number of risks, uncertainties and other important factors could cause actual developments and results to differ materially from UBS’s expectations. UBS’s business and financial performance could be affected by other factors identified in our past and future filings and reports, including those filed with the SEC. More detailed information about those factors is set forth in documents furnished by UBS and filings made by UBS with the SEC, including the Risk Factors filed on Form 6-K with the 2Q23 UBS Group AG report on 31 August 2023. UBS is not under any obligation to (and expressly disclaims any obligation to) update or alter its Forward looking statements, whether as a result of new information, future events, or otherwise.

Alternative Performance Measures: In addition to reporting results in accordance with International Financial Reporting Standards (IFRS), UBS reports certain measures that may qualify as Alternative Performance Measures as defined in the SIX Exchange Directive on Alternative Performance Measures, under the guidelines published by the European Securities Market Authority (ESMA), or defined as Non-GAAP financial measures in regulations promulgated by the US Securities and Exchange Commission (SEC). Please refer to “Alternative Performance Measures” in the appendix of UBS’s Quarterly Report for the fourth quarter of 2023 for a list of all measures UBS uses that may qualify as APMs. Underlying results are non-GAAP financial measures as defined by SEC regulations and as APMs in Switzerland and the EU.

Disclaimer: This presentation and the information contained herein are provided solely for information purposes, and are not to be construed as a solicitation of an offer to buy or sell any securities or other financial instruments in Switzerland, the United States or any other jurisdiction. No investment decision relating to securities of or relating to UBS Group AG, UBS AG, Credit Suisse AG, Credit Suisse (Schweiz) AG or their affiliates should be made on the basis of this document. No representation or warranty is made or implied concerning, and UBS assumes no responsibility for, the accuracy, completeness, reliability or comparability of the information contained herein relating to third parties, which is based solely on publicly available information. UBS undertakes no obligation to update the information contained herein.

Available Information: UBS’s Annual Report, Quarterly Reports, SEC filings on Form 20-F and Form 6-K, as well as investor presentations and other financial information are available at ubs.com/investors. UBS’s Annual Report on Form 20-F, quarterly reports and other information furnished to or filed with the US Securities and Exchange Commission on Form 6-K are also available at the SEC’s website: www.sec.gov

Basel III RWA, LRD and capital: Basel III numbers are based on the BIS Basel III framework, as applicable for Swiss systemically relevant banks (SRB). Numbers in the presentation are based on the revised Swiss SRB rules as of 1.1.20, unless otherwise stated. Basel III risk-weighted assets in this presentation are calculated on the basis of Swiss SRB rules as of 1.1.20 unless otherwise stated. Our RWA under BIS Basel III are the same as under Swiss SRB Basel III. Leverage ratio and leverage ratio denominator in this presentation are calculated on the basis of Swiss SRB rules as of 1.1.20, unless otherwise stated. Refer to the “Capital management” section in the 4Q23 report for more information.

Definitions: “Earnings per share” refers to diluted earnings per share. “Litigation” refers to net additions/releases to provisions for litigation regulatory and similar matters reflected in the income statement for the relevant period. “Net profit” refers to net profit attributable to shareholders. “Sustainability-focus and impact” refers to sustainability-focus and impact investing; sustainability focus refers to strategies that have sustainability as an explicit part of the investment guidelines, universe, selection, and/or investment process that drive the strategy; impact investing refers to strategies that have an explicit intention to generate measurable, verifiable, positive sustainability outcomes. “PPA” refers to purchase price allocation adjustments made in accordance with IFRS 3, *Business Combinations*, to bring the assets acquired and liabilities assumed to fair value, from the acquisition of the Credit Suisse Group.

Rounding: Numbers presented throughout this presentation may not add up precisely to the totals provided in the tables and text. Percentages and percent changes disclosed in text and tables are calculated on the basis of unrounded figures. Absolute changes between reporting periods disclosed in the text, which can be derived from numbers presented in related tables, are calculated on a rounded basis.

Tables: Within tables, blank fields generally indicate non-applicability or that presentation of any content would not be meaningful, or that information is not available as of the relevant date or for the relevant period. Zero values generally indicate that the respective figure is zero on an actual or rounded basis. Values that are zero on a rounded basis can be either negative or positive on an actual basis.

Numbers presented in US dollars unless otherwise indicated. Currency translation of monthly income statement items of operations with a functional currency other than the US dollar are translated with month-end rates into US dollar.

© UBS 2024. The key symbol and UBS are among the registered and unregistered trademarks of UBS. All rights reserved

Agenda

4Q23 results

Investor update

Q&A

Sergio P. Ermotti, Group CEO
Todd Tuckner, Group CFO

Key messages

- Completed first phase of strategic integration, stabilized the franchise with 77bn net new asset inflows and achieved underlying profitability since the acquisition with ~4bn gross cost saves in 2023
- Maintained strong capital position with CET1 capital ratio of 14.5%; USD 0.70 dividend per share (+27% YoY) to be proposed for FY23 and planning to repurchase up to 1bn of shares in 2024
- Clear path to achieve ~15% underlying RoCET1 by year-end 2026 through ~13bn gross cost saves, balance sheet optimization and reinvesting for sustainable growth
- Unique capital generative business model well positioned to deliver long-term growth and high-teen returns on capital

Stabilized Credit Suisse franchise and delivered on 2023 financial priorities

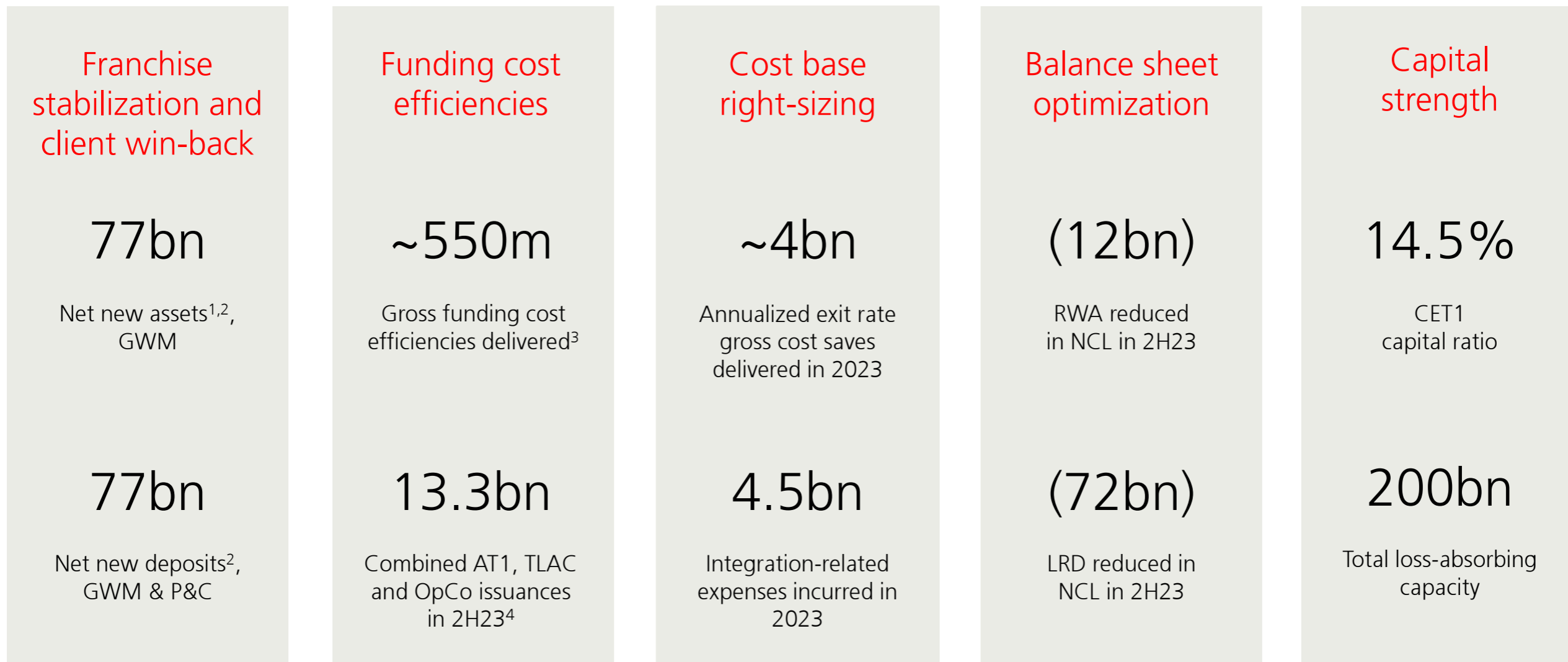

4Q23 underlying PBT of 0.6bn

Profits

m

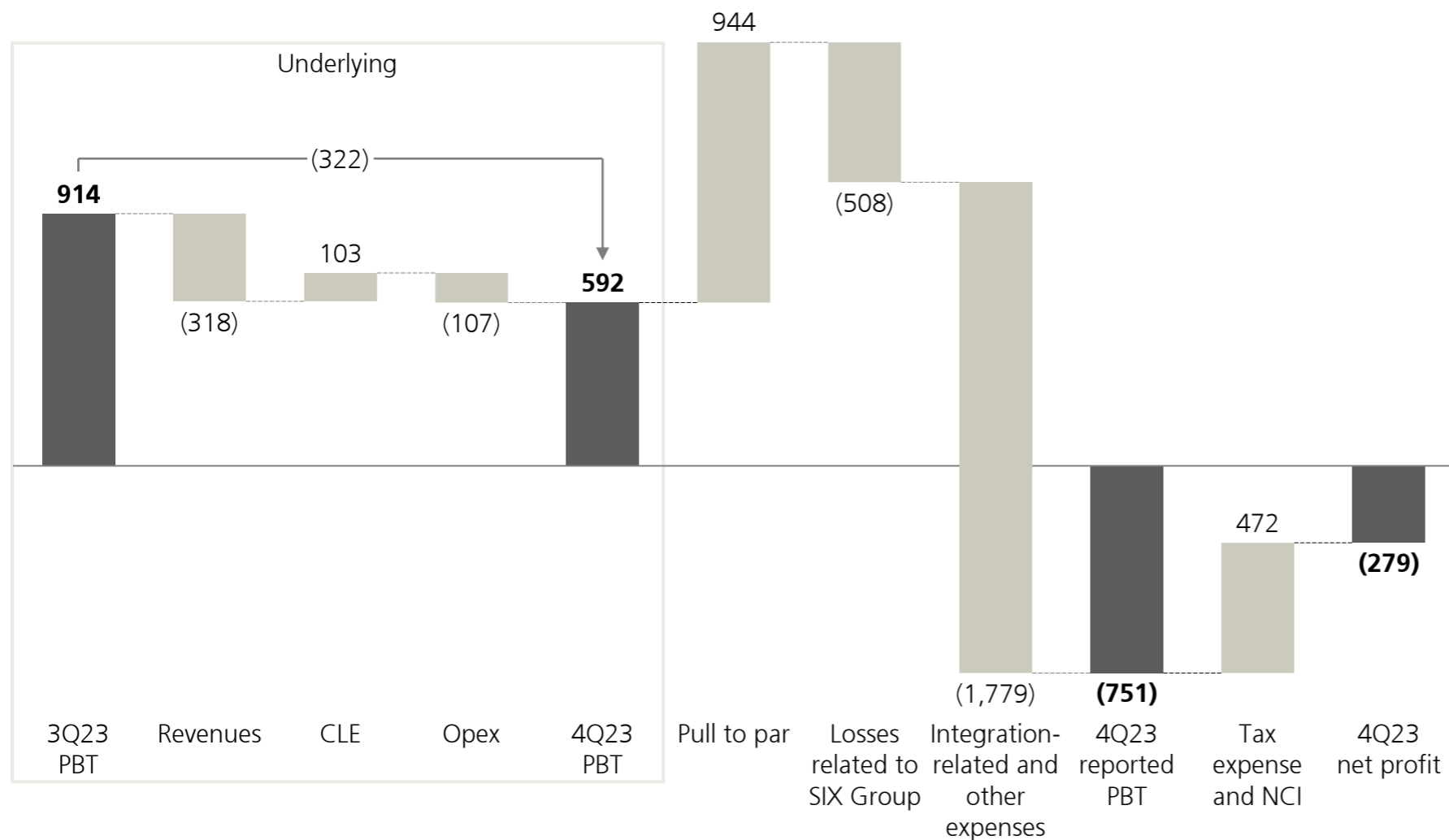

4Q23

(751m)	592m
PBT	PBT, underlying
(1.4%)	4.7%
RoCET1	RoCET1, underlying

FY23

29.9bn	4.0bn
PBT	PBT, underlying
29.0bn	0.1bn
Net profit	Net profit, excluding negative goodwill

4Q23 underlying total revenues 10.4bn, down 3% QoQ

Total revenues

m

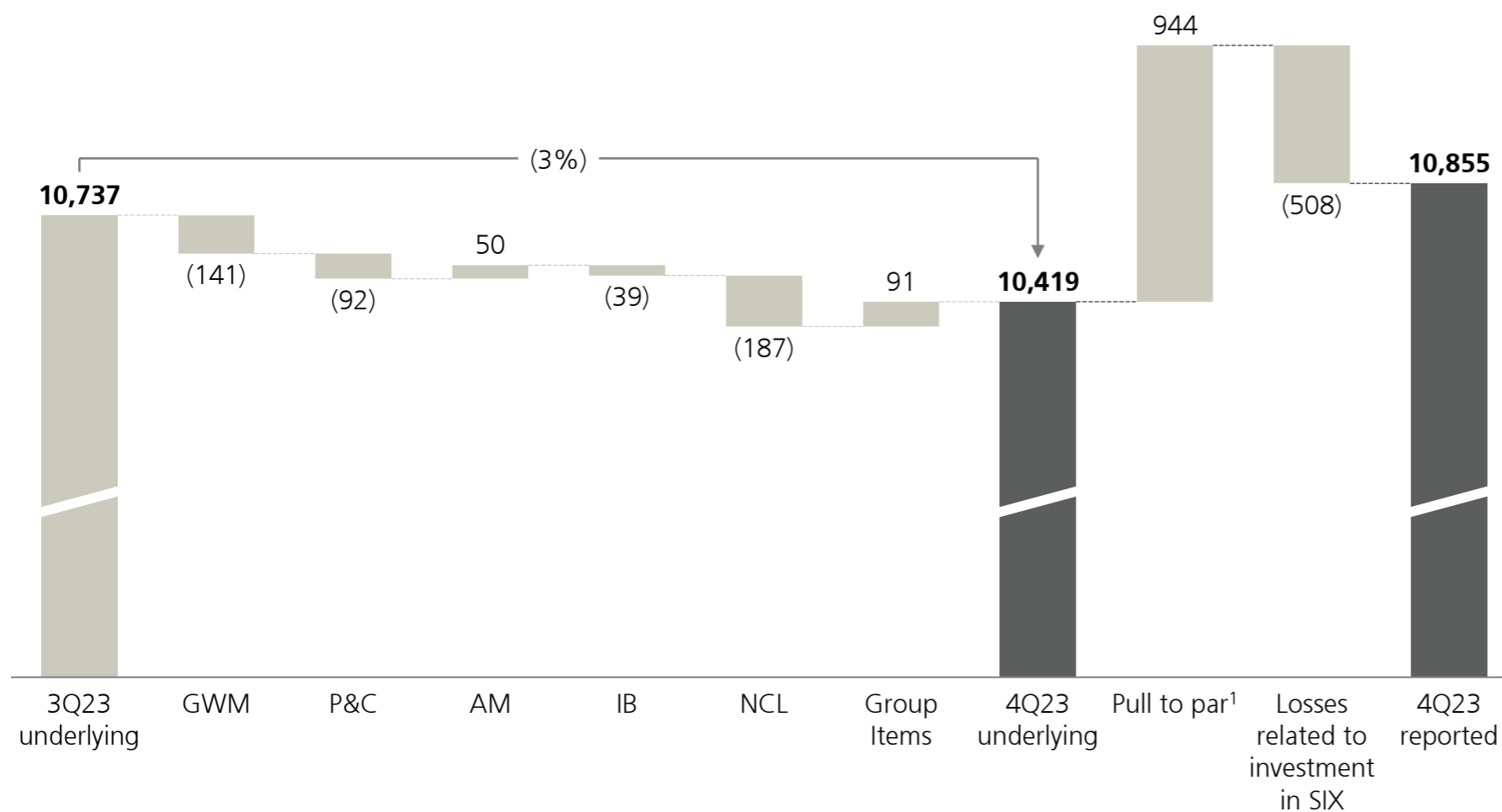

944m

Pull to par and other PPA effects not reflected in underlying in 4Q¹

~700m

Pull to par and other PPA effects expected in 1Q24^{1,2}

(508m)

Losses related to investment in SIX Group in 4Q23

4Q23 underlying operating expenses 9.7bn, up 1% QoQ

Operating expenses

m

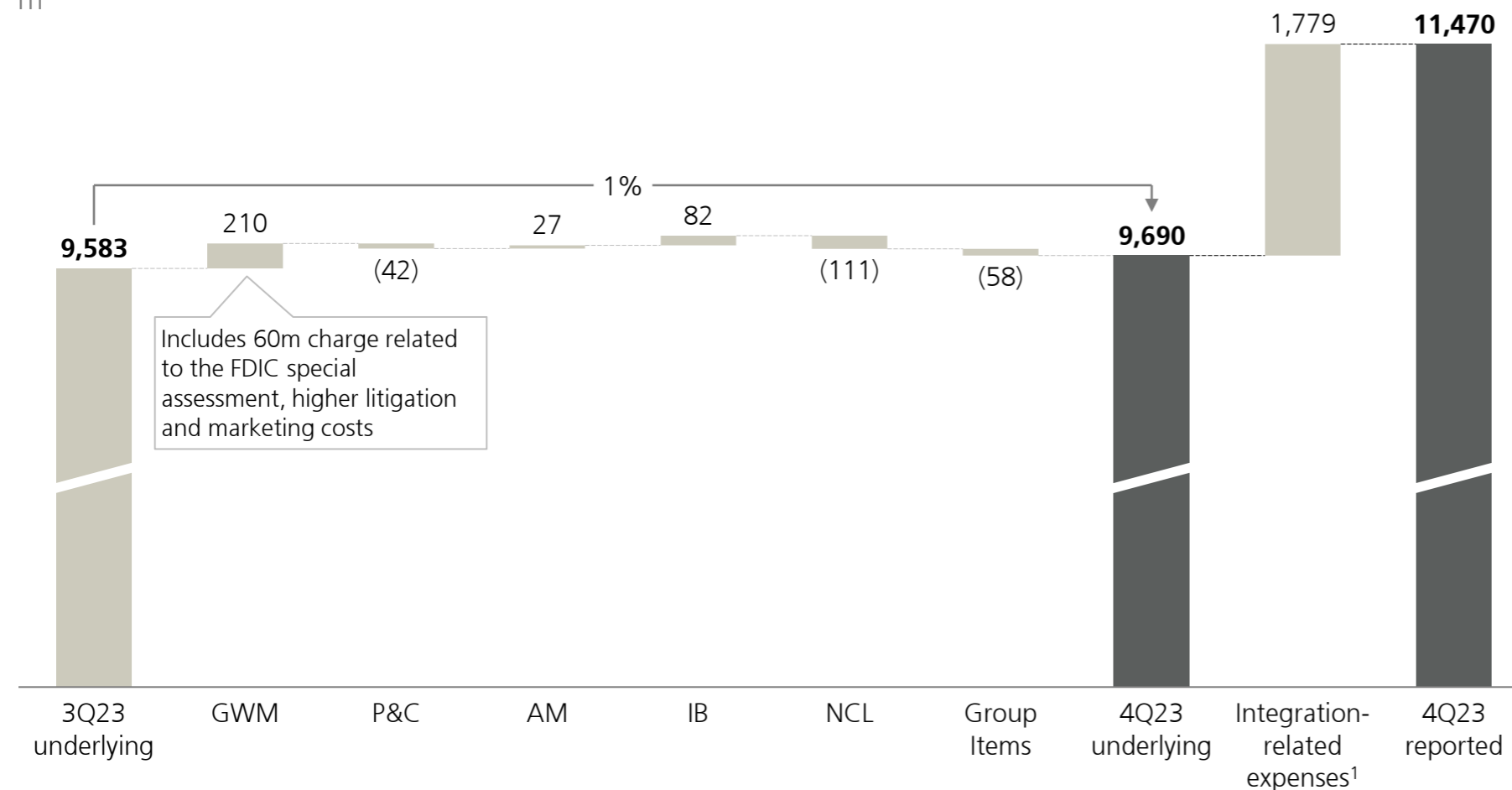

17k

Headcount reduction vs. Dec-22 pro forma²

~1bn

Integration-related expenses expected in 1Q24

135m

in UK Bank Levy and US FDIC charges in 4Q23

Global Wealth Management

	Underlying			Reported		
	4Q23	3Q23	QoQ	4Q23	3Q23	QoQ
<i>USD m, except where indicated</i>						
Total revenues	5,351	5,492	(3%)	5,444	5,810	(6%)
Net interest income	1,611	1,648	(2%)	1,872	1,946	(4%)
Recurring net fee income	2,818	2,886	(2%)	2,818	2,886	(2%)
Transaction-based income	904	939	(4%)	927	959	(3%)
Other income	18	19		(172)	19	
Credit loss expense / (release)	(7)	2		(7)	2	
Operating expenses	4,580	4,370	+5%	5,070	4,801	+6%
Profit before tax	778	1,119	(31%)	381	1,007	(62%)
Cost / income ratio	86%	80%	+6pp	93%	83%	+10pp
Invested assets, bn	3,850	3,617	+6%	3,850	3,617	+6%
Deposits, bn	467	440	+6%	467	440	+6%
Loans, bn	284	283	+1%	284	283	+1%

Underlying 4Q23 vs. 3Q23

PBT 778m, excluding 490m of integration-related expenses, 284m accretion of PPA and 190m losses related to investment in SIX Group

Total revenues 5,351m, (3%)

Credit loss expense (7m)

Operating expenses 4,580m, +5% including a 60m charge related to the FDIC special assessment, higher litigation and marketing costs

Net new assets +21.8bn driven by inflows across APAC, Americas and Switzerland, partly offset by outflows in EMEA

Invested assets +6% reflecting positive market performance, FX and NNA inflows

Net new deposits +16.0bn

Net new loans (6.9bn)

Personal & Corporate Banking (CHF)

CHF m, except where indicated	Underlying			Reported		
	4Q23	3Q23	QoQ	4Q23	3Q23	QoQ
Total revenues	2,042	2,159	(5%)	2,136	2,556	(16%)
Net interest income	1,179	1,189	(1%)	1,505	1,550	(3%)
Recurring net fee income	421	431	(2%)	421	431	(2%)
Transaction-based income	391	507	(23%)	427	543	(21%)
Other income	50	31		(217)	31	
Credit loss expense / (release)	72	154	(53%)	72	154	(53%)
Operating expenses	1,175	1,232	(5%)	1,363	1,405	(3%)
Profit before tax	794	773	+3%	701	997	(30%)
Cost / income ratio	58%	57%	0pp	64%	55%	+9pp
Deposits, bn	273	269	+2%	273	269	+2%
Loans, bn	284	288	(2%)	284	288	(2%)

Underlying 4Q23 vs. 3Q23

PBT 794m, excluding 362m accretion of PPA, 267m losses related to investment in SIX Group, 163m of integration-related expenses and 25m amortization from newly recognized intangibles

Total revenues 2,042m, (5%) mostly due to lower transaction-based income

Credit loss expense 72m, primarily related to CS Swiss Bank

Operating expenses 1,175m, (5%) on lower personnel and real estate expenses

Cost / income 58%

Net new deposits +7.2bn

Net new loans (4.8bn)

Asset Management

	Underlying			Reported		
	4Q23	3Q23	QoQ	4Q23	3Q23	QoQ
<i>USD m, except where indicated</i>						
Total revenues	805	755	+7%	805	755	+7%
Net Management fees	725	737	(2%)	725	737	(2%)
Performance fees	52	18	+194%	52	18	+194%
Net gain from disposals	27			27		
Credit loss expense / (release)	(1)	0		(1)	0	
Operating expenses	625	599	+4%	691	724	(5%)
Profit before tax	180	156	+16%	115	31	+269%
Cost / income ratio	78%	79%	(2pp)	86%	96%	(10pp)
Invested assets, bn	1,649	1,559	+6%	1,649	1,559	+6%
Net new money, bn	(12)	(1)		(12)	(1)	

Underlying 4Q23 vs. 3Q23

Total revenues 805m, +7% driven by higher performance fees and 27m net gains on disposals

Operating expenses 625m, +4% mainly reflecting higher personnel expenses and litigation charges

Invested assets 1,649bn, +6% reflecting positive market performance and FX, partly offset by NNM outflows

Net new money (12.2bn), driven by outflows in indexed equities

Investment Bank

USD m, except where indicated

	4Q23	Underlying			Reported	
		3Q23	QoQ	YoY	4Q23	4Q22
Total revenues	1,861	1,900	(2%)	+11%	2,139	1,682
Global Banking	561	447	+26%	+69%	836	331
Advisory	190	191	(1%)	+11%	190	172
Capital Markets	371	256	+45%	+133%	646	159
Global Markets	1,300	1,452	(10%)	(4%)	1,303	1,351
Execution Services	414	379	+9%	+11%	414	371
Derivatives & Solutions	443	605	(27%)	(18%)	446	541
Financing	442	468	(6%)	+1%	442	438
Credit loss expense / (release)	48	4		+496%	48	8
Operating expenses	2,094	2,012	+4%	+34%	2,260	1,563
Profit before tax	(280)	(116)			(169)	112
Cost / income ratio	112%	106%	+7pp	+20pp	106%	93%

Underlying 4Q23 vs. 4Q22

Global Banking revenues +69%

- Advisory +11%, outperforming the global M&A fee pool
- Capital Markets +133%, on higher LCM, DCM and ECM revenues

Global Markets revenues (4%)

- Execution Services +11% driven by higher Cash Equities and eFX volumes
- Derivatives & Solutions (18%) with increase in Equities more than offset by decrease in Rates and FX
- Financing +1%

Of which:

- Equities 1,003m, +14%
- FRC 297m, (36%)

Operating expenses 2,094m, +34% mainly driven by personnel expenses, including from the retained portions of Credit Suisse's investment bank, and technology

Non-core and Legacy

	Underlying			Reported		
	4Q23	3Q23	QoQ	4Q23	3Q23	QoQ
<i>USD m, except where indicated</i>						
Total revenues	162	350	(54%)	162	350	(54%)
Credit loss expense / (release)	15	59		15	59	
Operating expenses	1,124	1,234	(9%)	1,873	2,152	(13%)
Profit before tax	(977)	(943)		(1,726)	(1,861)	
RWA (bn)	72	77	(7%)	72	77	(7%)
LRD (bn)	137	156	(12%)	137	156	(12%)

Underlying 4Q23 vs. 3Q23

PBT (977m), excluding 749m of integration-related expenses

Total revenues driven by net gains from position marks and unwinds

Credit loss expense 15m

Operating expenses 1,124m, (9%) largely driven by lower personnel expenses

RWA (6bn), driven by an accelerated roll-off arising from active unwind actions

LRD (19bn), driven by reductions across all asset classes and lower HQLA

Maintained capital strength with CET1 ratio comfortably above guidance

CET1 capital ratio

CET1, bn

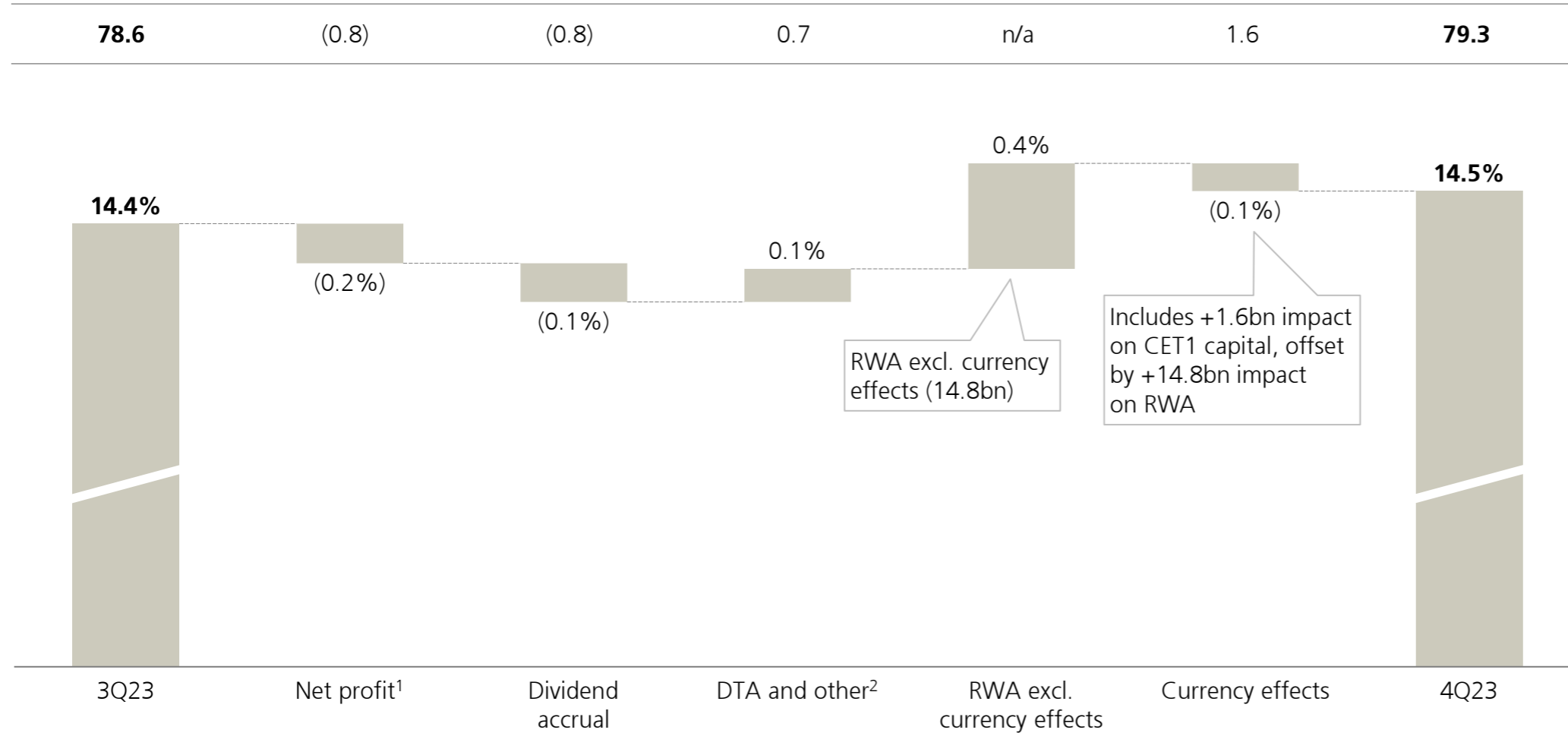

14.5%
CET1 capital ratio
Guidance: ~14%

4.7%
CET1 leverage ratio
Guidance: >4.0%

547bn
RWA
Flat QoQ, (15bn) QoQ
ex-currency effects



¹ Excluding deferred tax expense; ² Includes 1.5bn deferred tax assets recognized for temporary differences, (0.6bn) from compensation and own share-related capital components, (0.3bn) from amortization of transitional CET1 PPA adjustments (net of tax) and movements related to other items



Investor update

Attractive business model with unique global asset gathering businesses

Revenue mix vs North American and European GSIBs

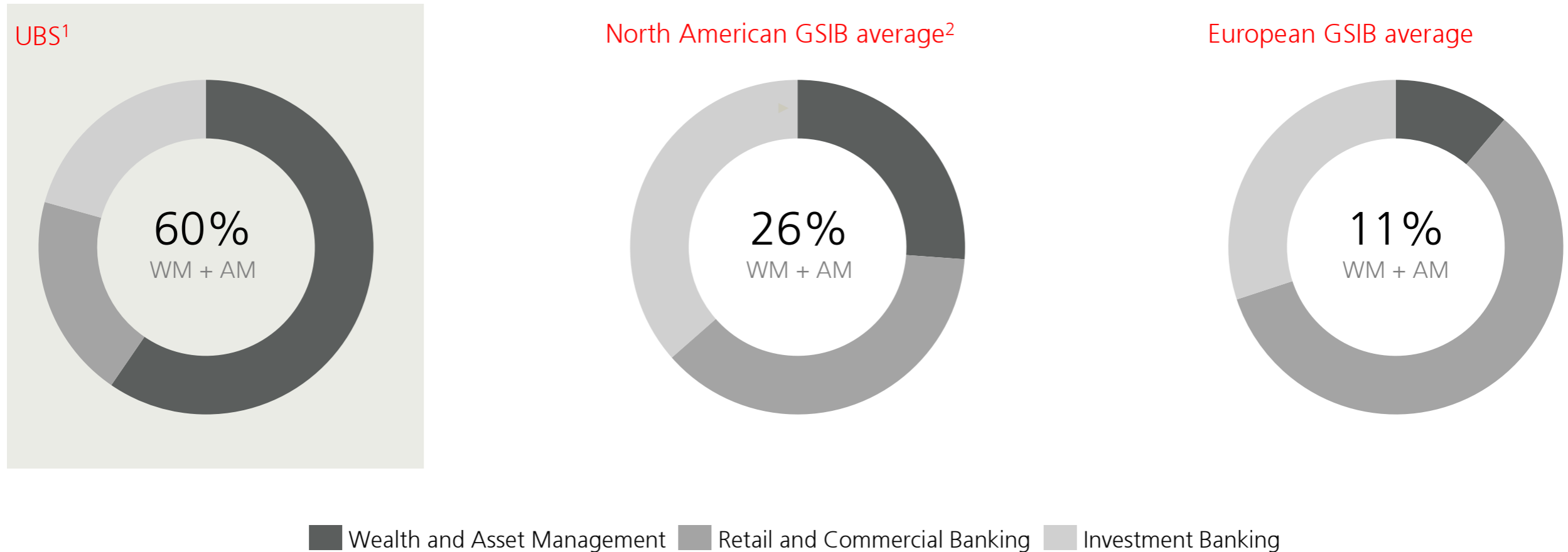

Accelerating our strategy by enhancing client franchises, capabilities and scale



Global Wealth Management

- 3.8trn invested assets with unrivaled geographic footprint
- #1 in Asia, Latin America, EMEA and Switzerland¹
- Aligned client focus on UHNW and entrepreneurs
- Aiming to achieve >5trn invested assets by 2028



Personal & Corporate Banking

- Leading bank in Switzerland
- Accelerating growth plans in the corporate client segment
- Strengthened digital offering
- Enhanced investment and innovation capabilities



Asset Management

- 1.6trn invested assets
- #3 European-based Asset Manager (#11 globally)²
- Expanded presence in North America and Asia
- Accelerating growth in alternatives and scale in customized indexing



Investment Bank

- Reinforcing and accelerating UBS strategic positioning
- Strengthening equities, research and global banking
- Continuous focus on UHNW, GFIW and Swiss corporate banking clients
- <25% of Group RWA³



Underlying revenue contribution⁴

Executing to capture long-term growth and value creation



Restructuring and delivering on integration milestones by end-2026

Illustrative key milestone timeline (examples)

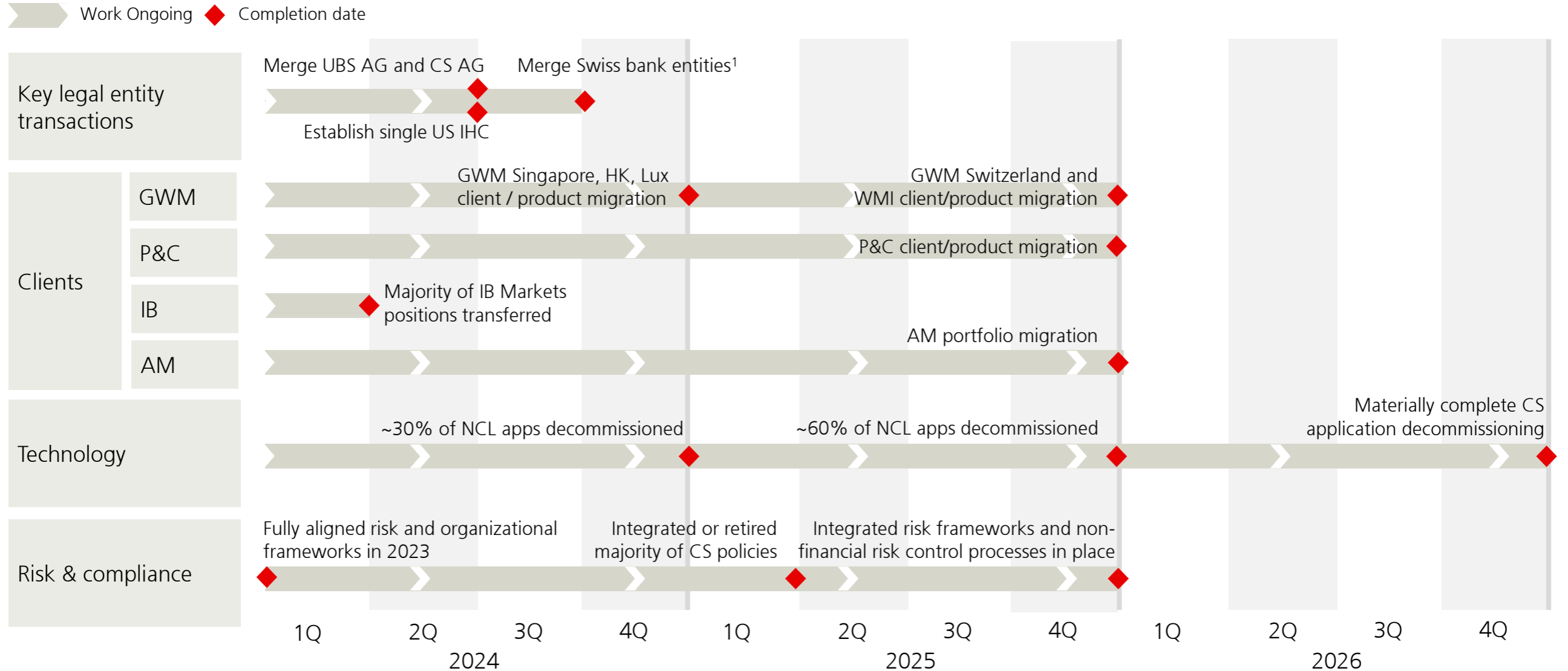

Building capacity to invest and achieve <70% cost/income ratio by end-2026

~13bn gross cost saves to fund reinvestments

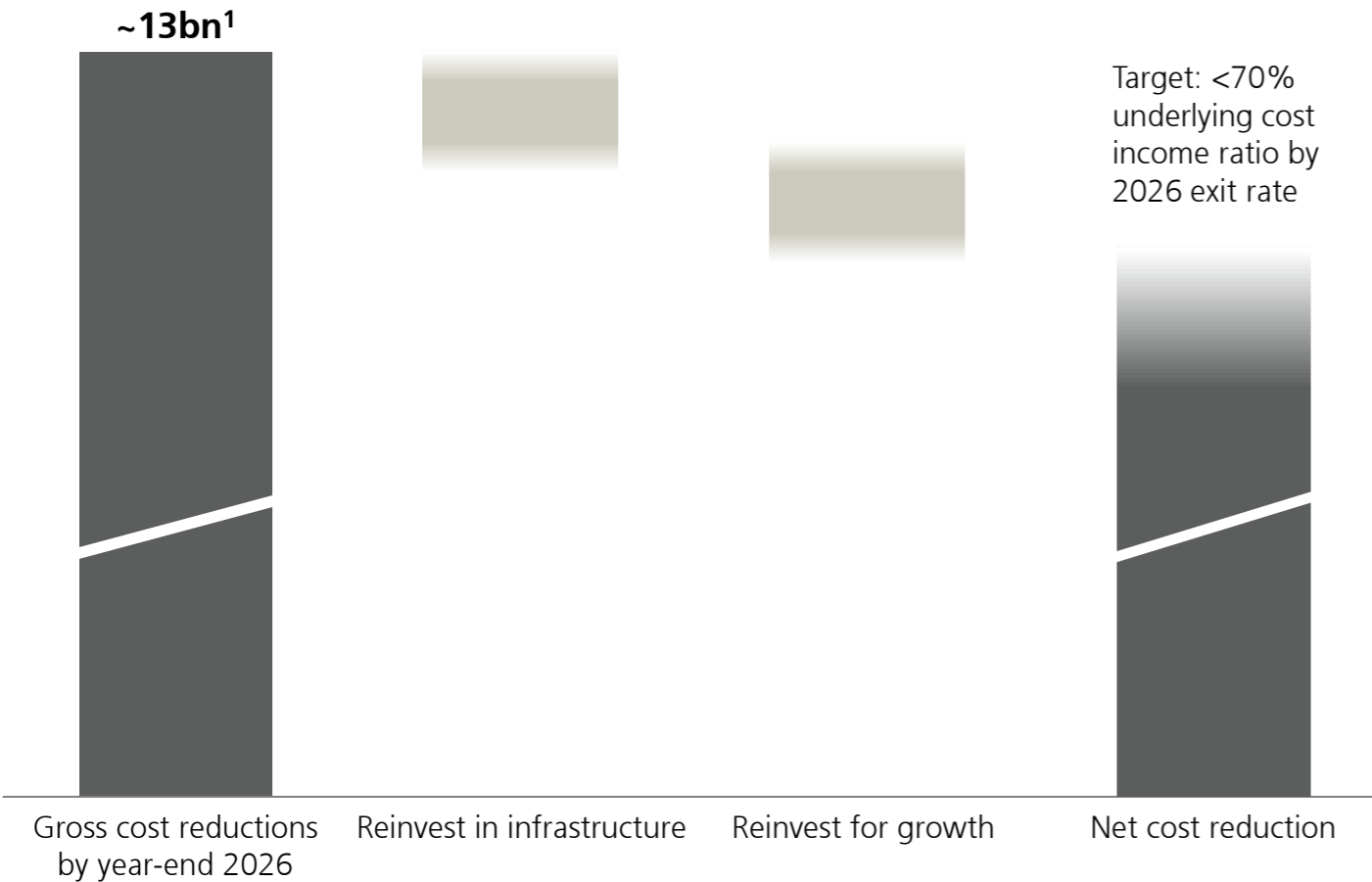

Investment priorities

Improving client experience

Products, capabilities and coverage

Digital delivery and leading technology

Investing in infrastructure

Reinforcing resilience of our technology infrastructure

Continuous enhancement of risk and controls

Optimizing financial resources to enable sustainable growth and higher returns

Non-core and Legacy wind-down

>6bn

Capital release by 2026 year-end¹

Increased resource discipline in core businesses

Reduction

of low-return exposures

Alignment

of return hurdle frameworks and repricing

Optimization

of models and hedging activities

Group underlying revenues / RWA
Pre-impact from B3f and model updates

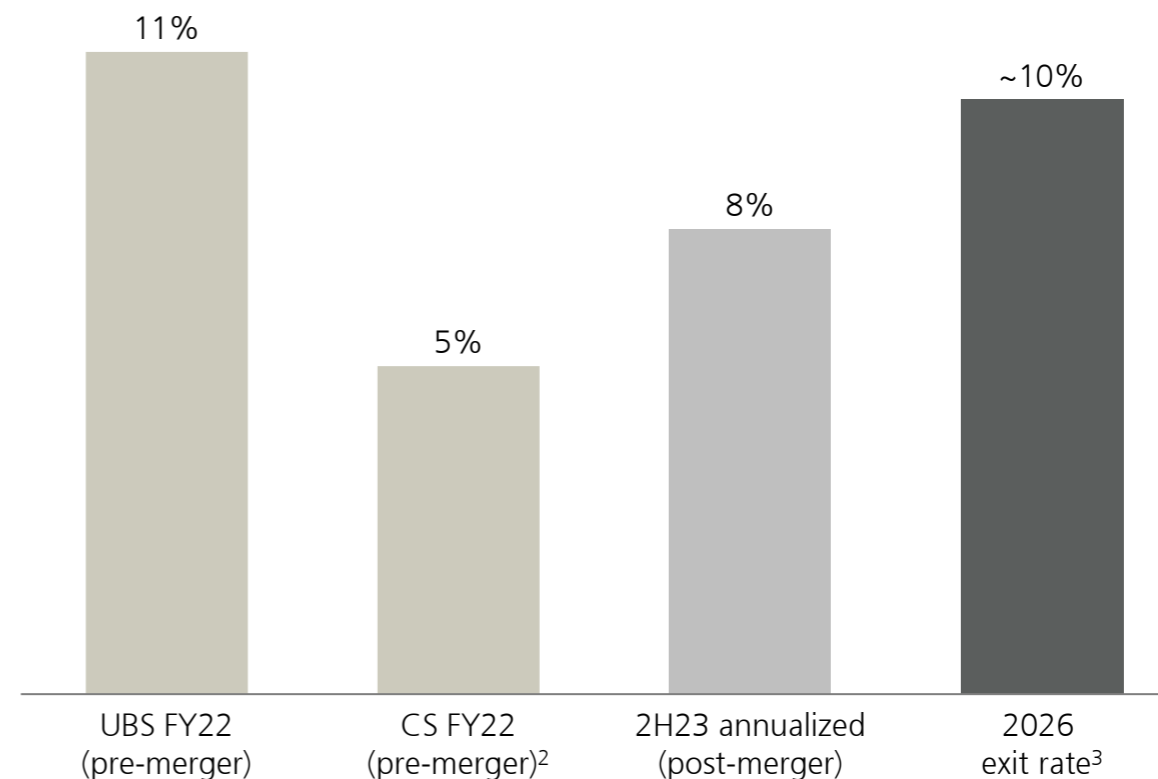

GWM – Building on our unrivaled global scale and footprint

 Invested assets, USD bn

Switzerland:

#1

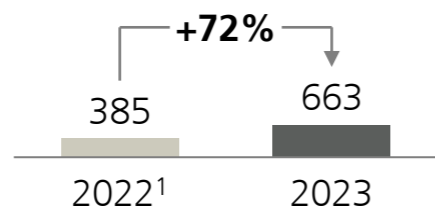

EMEA:

#1

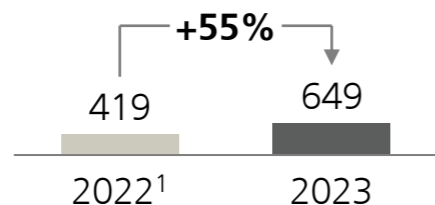

APAC:

#1

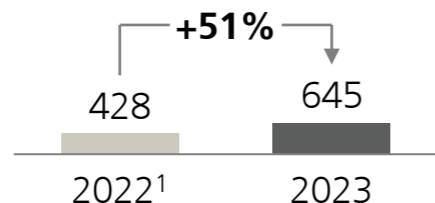

Americas:

#1 LatAm

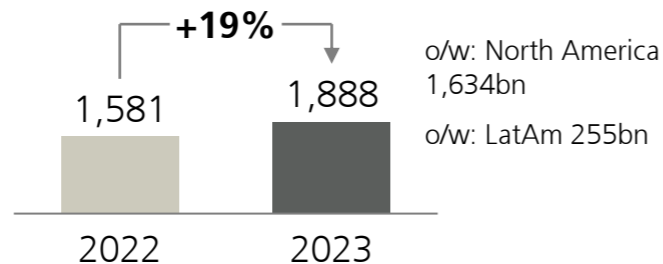

Medium-term priorities

Staying close to clients while growing the platform

- Capitalize on win-back opportunity and gain share of wallet
- Leverage enhanced product offering and capabilities
- Increase advisor productivity through digital tools

Capitalize from regional scale through integration

- Improve resource, risk and pricing discipline
- Converge and streamline the platform and solution offering
- Capture cost and revenue synergies

Institutionalize and grow business in US

- Strengthen and build-out core banking infrastructure
- Deliver expanded capabilities to drive growth
- Leverage booking platform for global clients



GWM – Ambition to surpass 5trn of invested assets over next five years

Invested assets
trillion

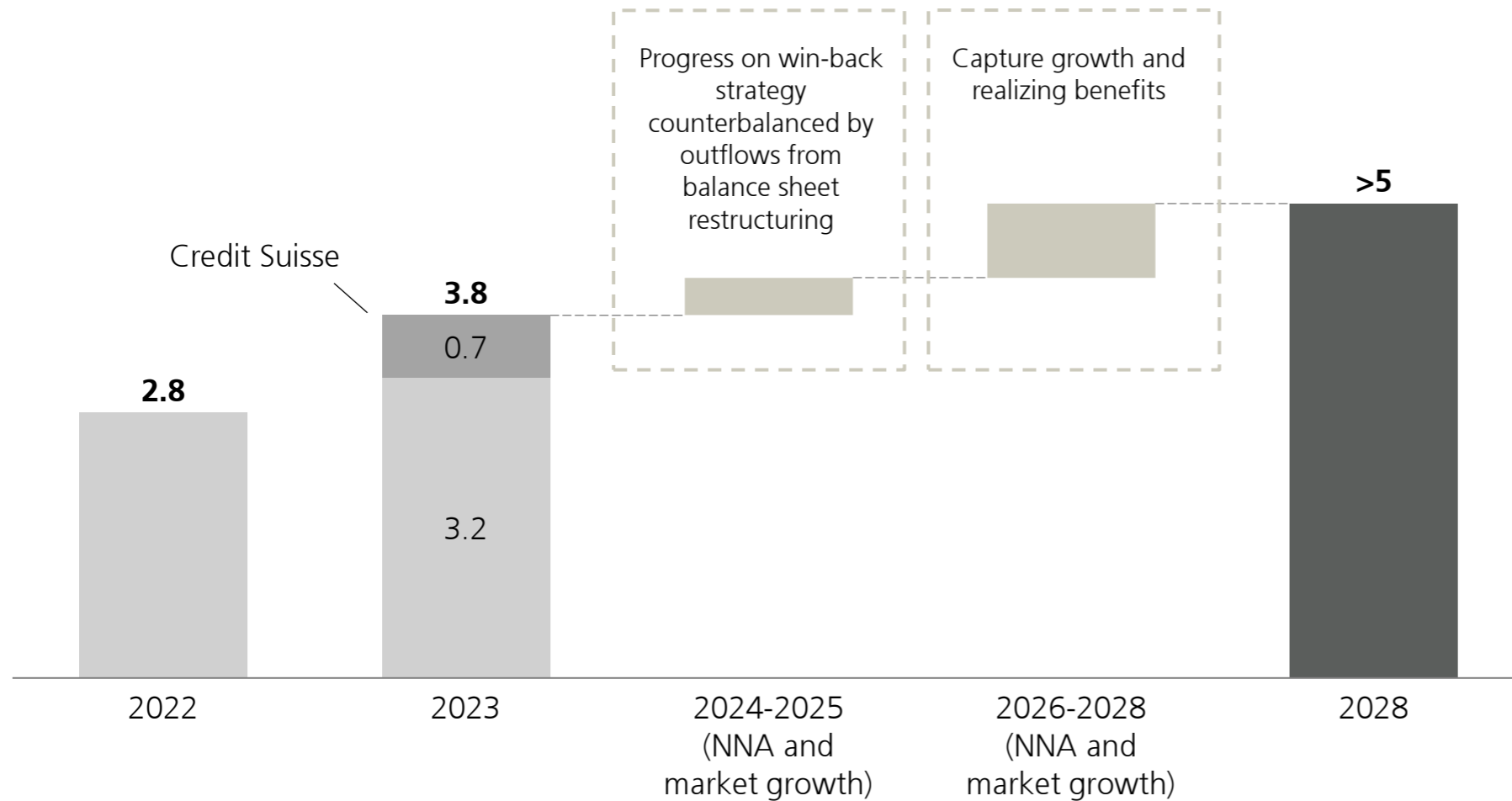

Ambitions

~100bn

NNA per annum through 2025 as we optimize for greater capital efficiency, building to...

~200bn

NNA per annum by 2028

<70%

Underlying cost / income ratio by 2026 exit rate

P&C – #1 bank in Switzerland with unparalleled reach and strong returns

>90%

of large Swiss corporations served¹

>1/3

of Swiss Households served²

Total revenues³
2H23



PBT³
2H23



Ambition

<50%

Underlying
cost / income ratio
by 2026 exit rate

Medium-term priorities

Clients

- Leading bank for multi-nationals and SMEs
- Leading digital capabilities
- Access to group wide investment and innovation

Integration

- Client retention and win-back
- Legal merger of UBS Switzerland and Credit Suisse (Schweiz) AG
- Client migration

Productivity and efficiency

- Eliminate overlaps in branch footprint
- Capture synergies
- Optimize risk-adjusted returns

AM – Improved positioning across key asset classes and growth markets

Invested assets

trillion

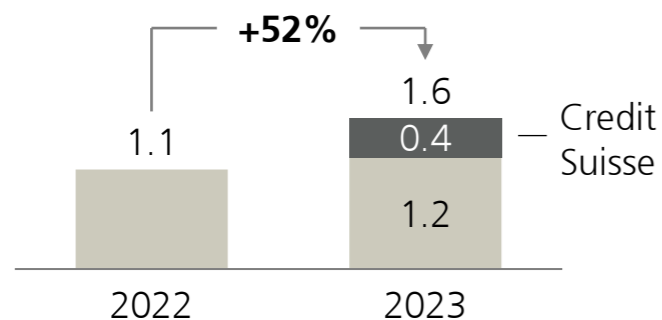

Asset class split

% of invested assets excl. associates



Ambition

<70%

Underlying cost / income ratio by 2026 exit rate

Medium-term priorities

Clients

- Expand differentiated Alternatives and Sustainable Investing capabilities
- Leverage scale in customized Indexing
- Grow SMA partnership with GWM
- Capitalize on global footprint

Integration

- Client retention and cross-selling
- Fund mergers and rationalization
- Portfolio and client migration

Productivity and efficiency

- Complete non-core divestments
- Capture synergies
- Complete build out of tech platforms

IB – Enhancing client offering while maintaining capital discipline

Revenue mix by region

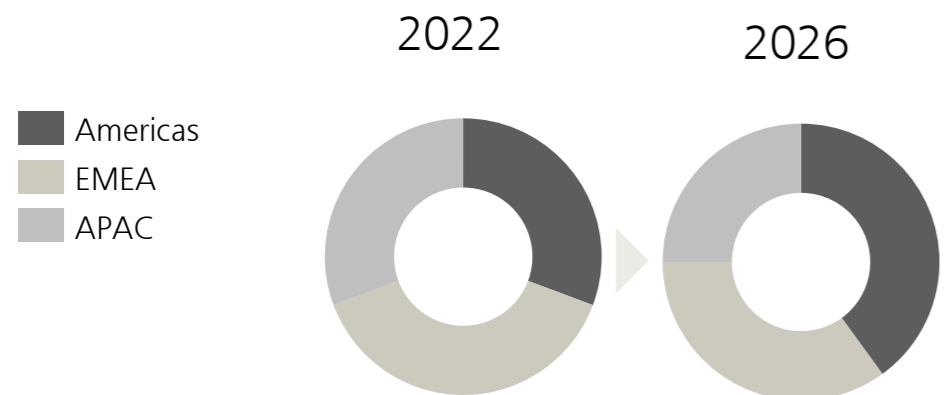

Revenue mix by business

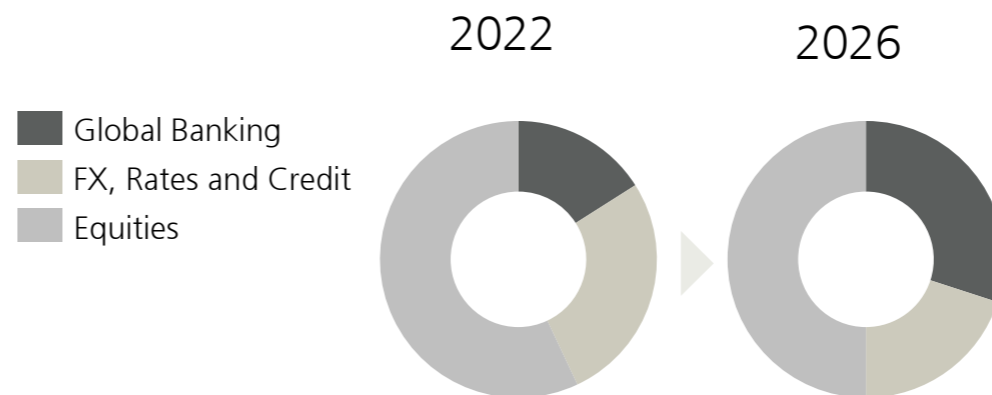

Medium-term priorities

Clients

- Strengthening our capabilities and partnership with GWM
- Enhanced banking coverage of financial sponsors and growth sectors¹
- Deliver deepened markets capabilities to institutional clients
- Increased research stock coverage, in line with US peers

Integration

- Global Banking coverage integration completed in 4Q23
- Majority of IB Markets positions transferred by 1Q24

Productivity and efficiency

- Ramp up new employee productivity
- Maintain risk discipline
- No more than 25% of Group RWA consumption²

Ambition

~15%

Underlying RoAE, through the cycle

Non-core and Legacy – driving lower costs and efficient capital release

Clear mandate

Reduce costs

Release capital

Protect our customer franchise

Unwind expected to be substantially complete by year-end 2026

Underlying operating expenses
bn

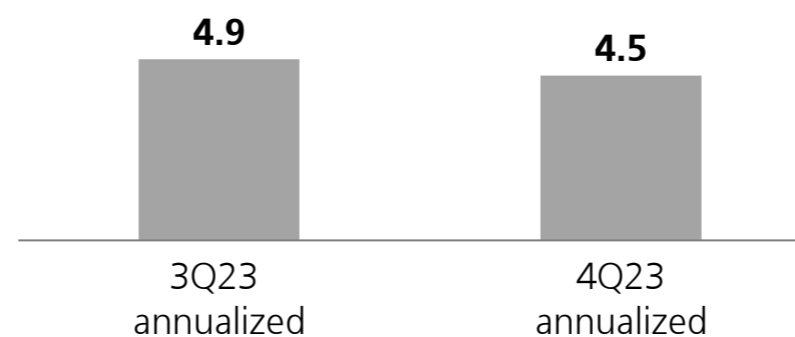

Total RWA
bn

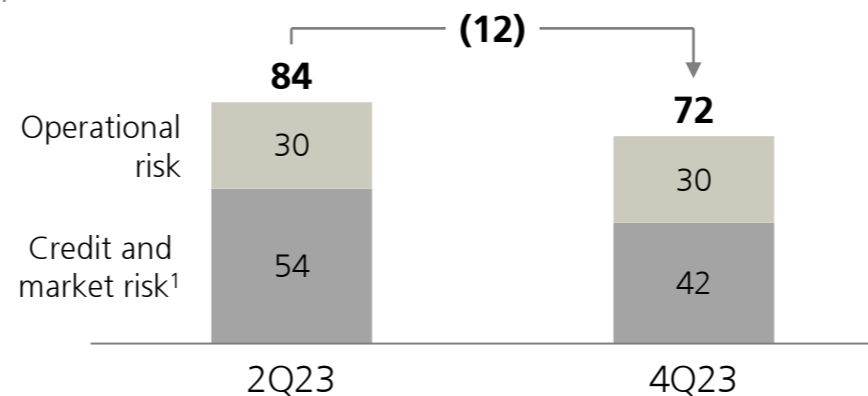

Ambitions

PBT: ~(-1.0bn)



~5% of
Group RWA

2026 year-end

Balancing resiliency, growth and attractive capital returns

1 Balance sheet for all seasons

- ~14% CET1 capital ratio
- ~18% total going concern ratio by YE29 to address increasing requirements
- >4.0% CET1 leverage ratio

2 Sustainable growth

- Ample capacity for return-accretive growth
- Funded organically from Non-core and Legacy unwind, efficiencies in core businesses and scale

3 Dividends

- USD 0.70 ordinary dividend per share (+27% YoY) to be proposed for FY23
- Committed to progressive dividends
- Accruing for mid-teen % dividend per share increase in 2024

4 Share buybacks

- Planning for up to USD 1bn of buybacks in 2024, commencing after completion of parent bank merger
- Ambition for FY26 share buybacks to exceed FY22 levels

Rebuilding profitability while restructuring for sustainable growth

Group underlying return on CET1 capital

Illustrative

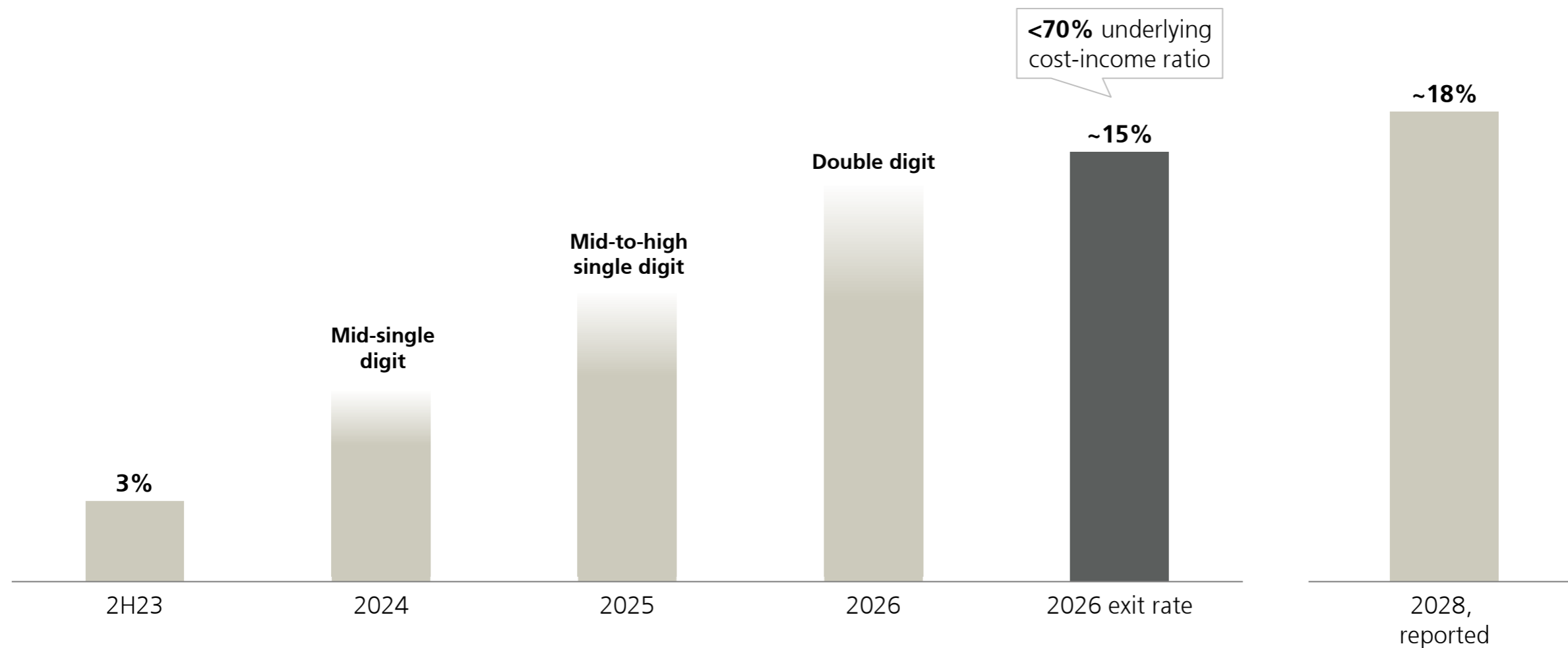



Investor update: Financials

Our path to ~15% underlying RoCET1 by year-end 2026

Reiterating key levers

- A Franchise stabilization, client win-back and growth**
- B Funding cost efficiencies**
- C Cost base right-sizing**
- D Balance sheet optimization**

Underlying RoCET1 bridge

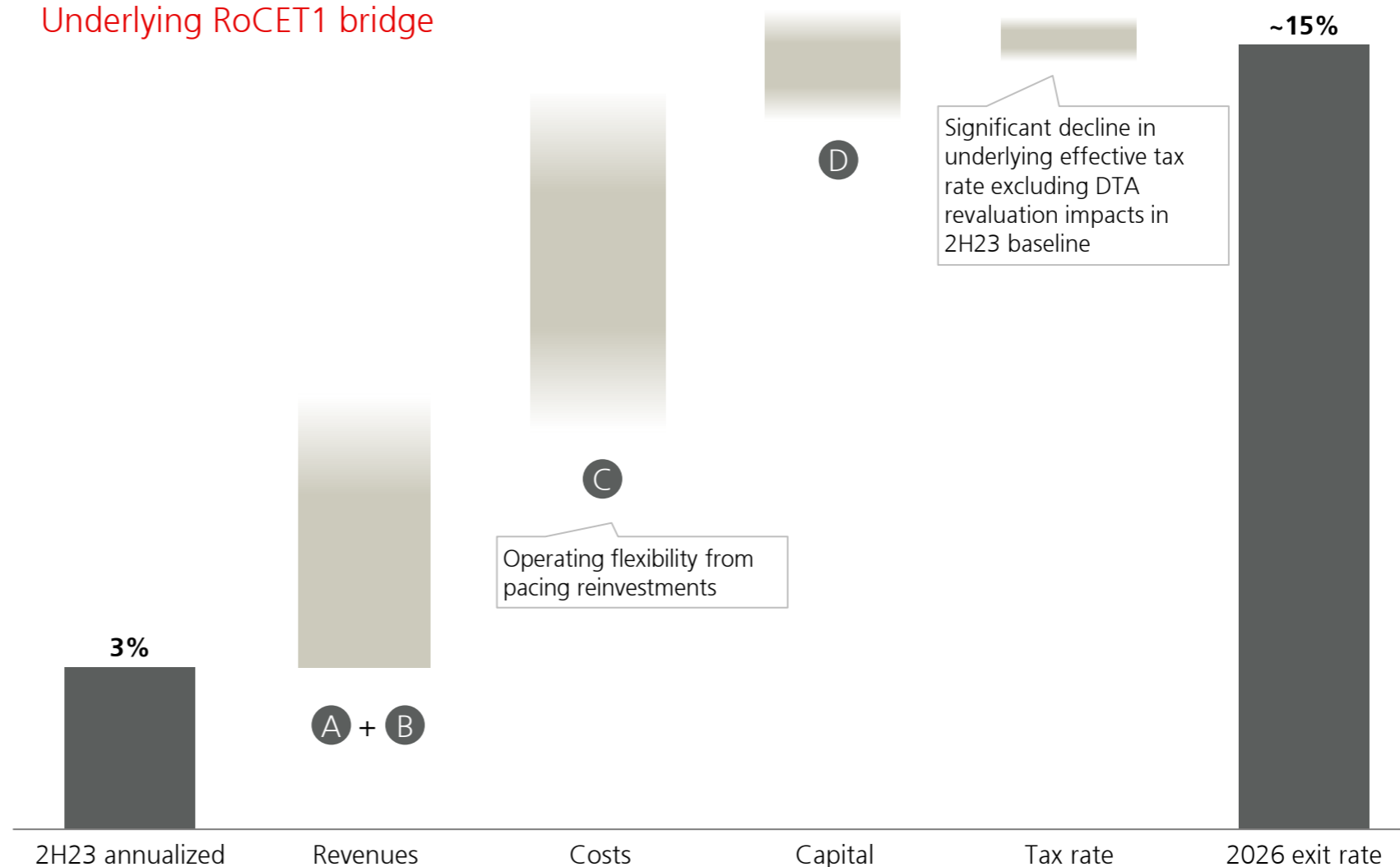

Revenue plans reflect enhanced capabilities and improved productivity

Underlying revenue bridge to 2026 exit rate (illustrative)

bn

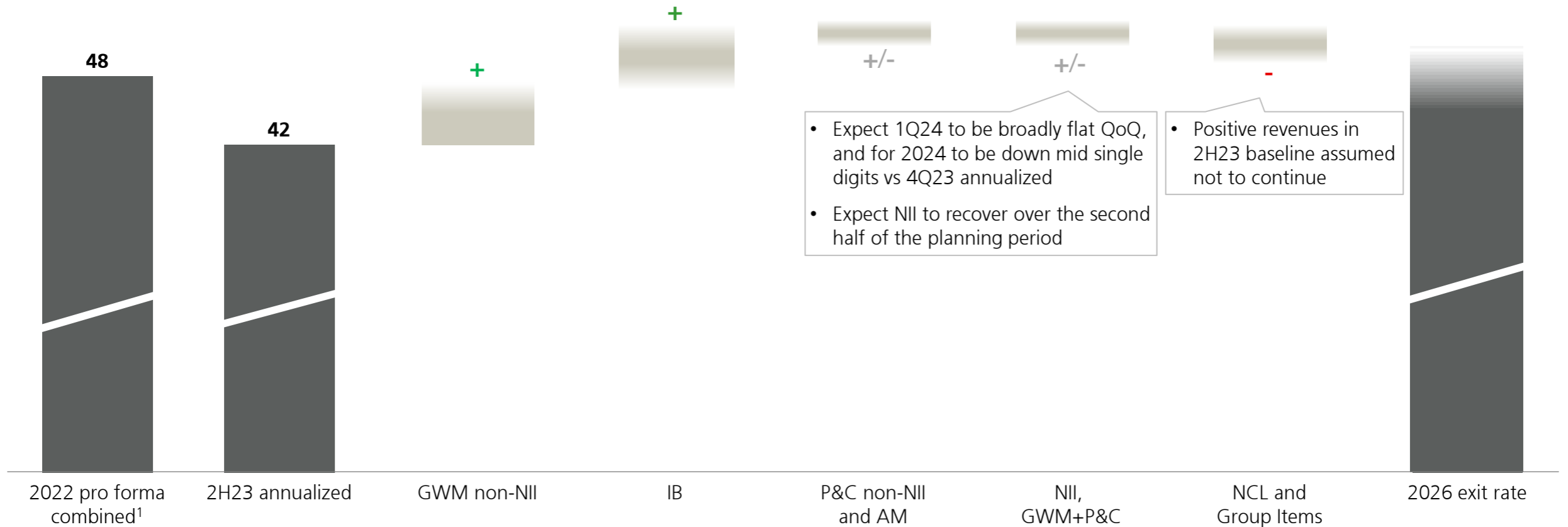

Forward looking figures based on constant FX rates; **1** FY22 baseline is pro forma combined, Credit Suisse FY22 baseline based on adjusted view with further adjustment to reclassify CHF 1.0bn of commission costs from expenses to contra-revenue to align further with IFRS accounting treatment

~13bn of cumulative gross cost saves to be achieved by year-end 2026

Cumulative gross cost reductions¹

% of total saves, exit rates

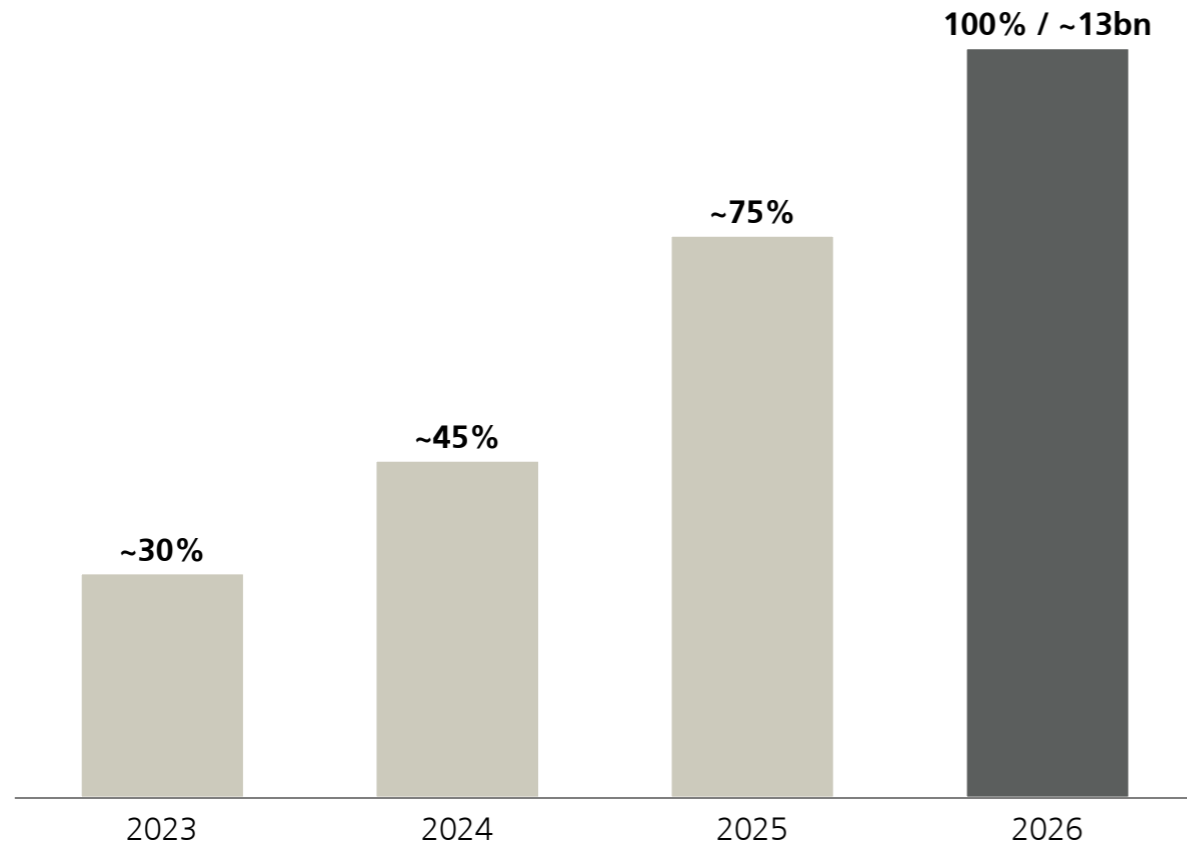

Cumulative integration-related expenses

% of total cumulative integration related expenses

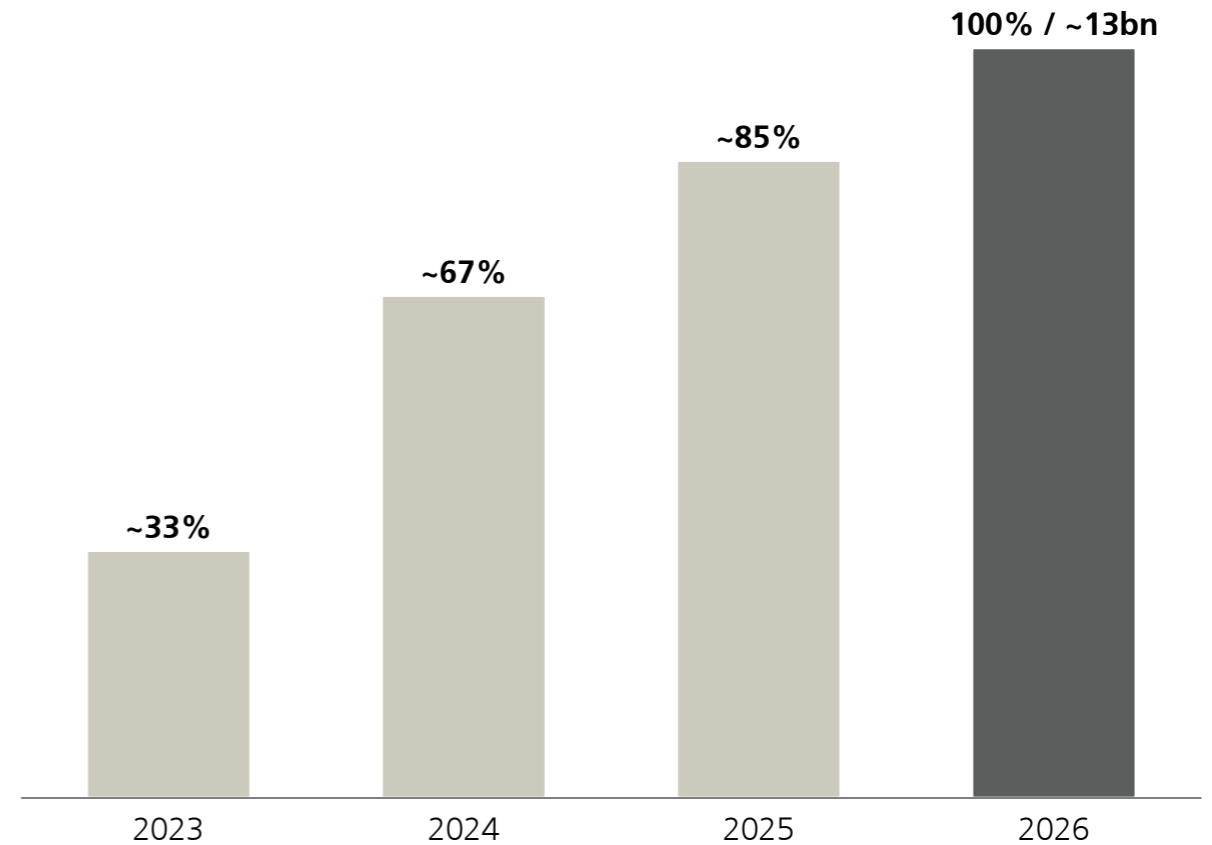

Non-core and Legacy to be a key contributor to Group net cost saves

Non-core and Legacy underlying cost trajectory
bn

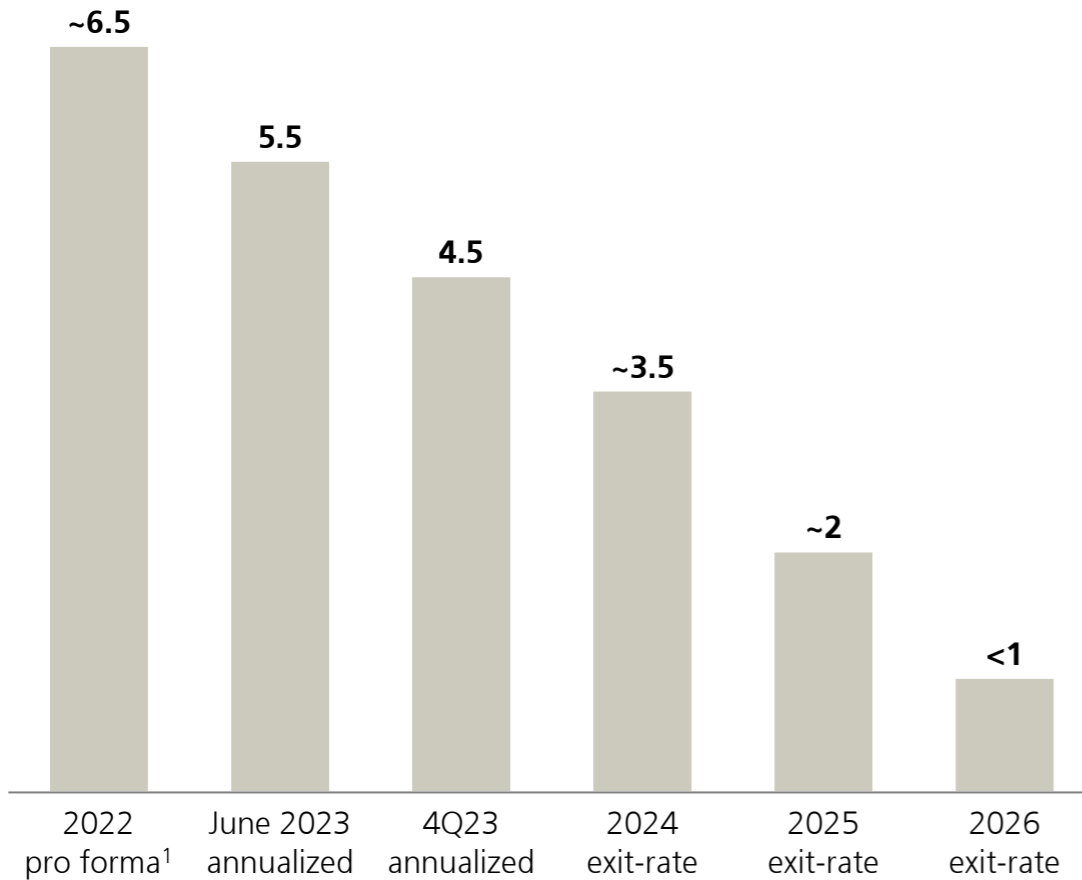

Cost mix
2H23

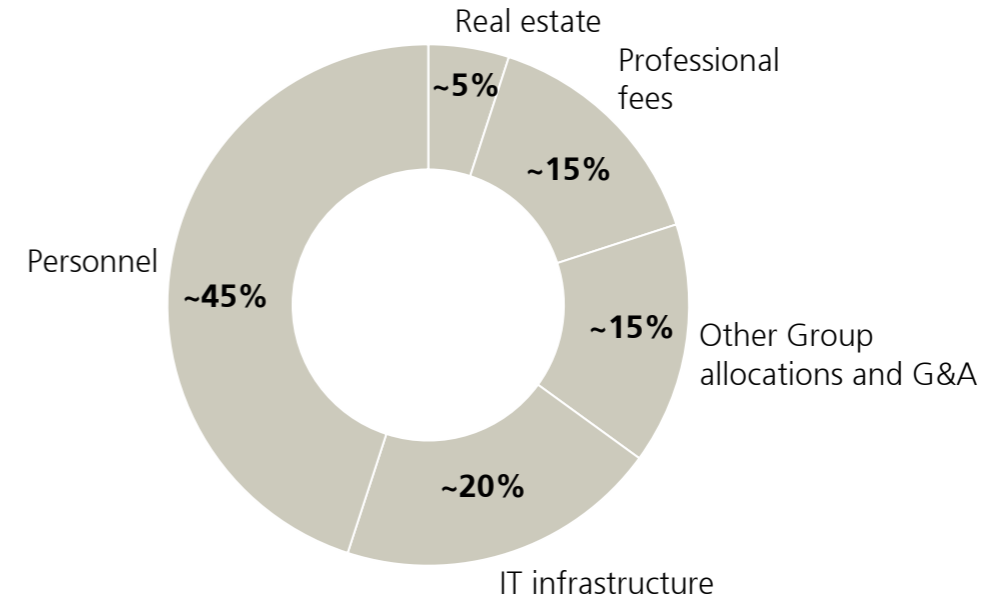

Reducing complexity and infrastructure dependency

	Jun-23	YE23	YE24	YE25	YE26
IT apps	~1,250	~1,100	~850	~500	~0
Number of books	~14k	~12k	~8.5k	~4.5k	~0.5k

Balance sheet for all seasons remains the foundation of our success

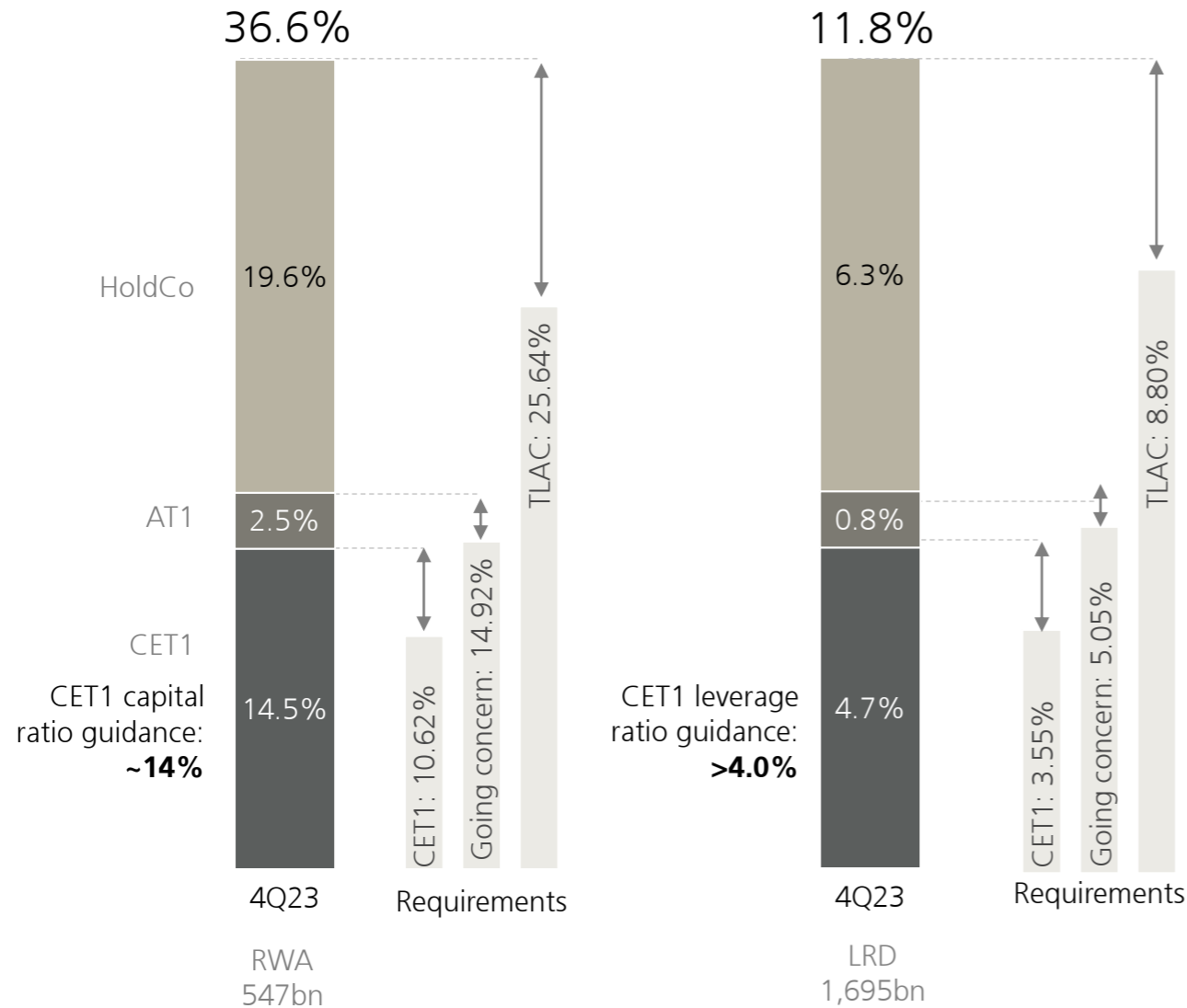

Prudent capital and liquidity management
31.12.23

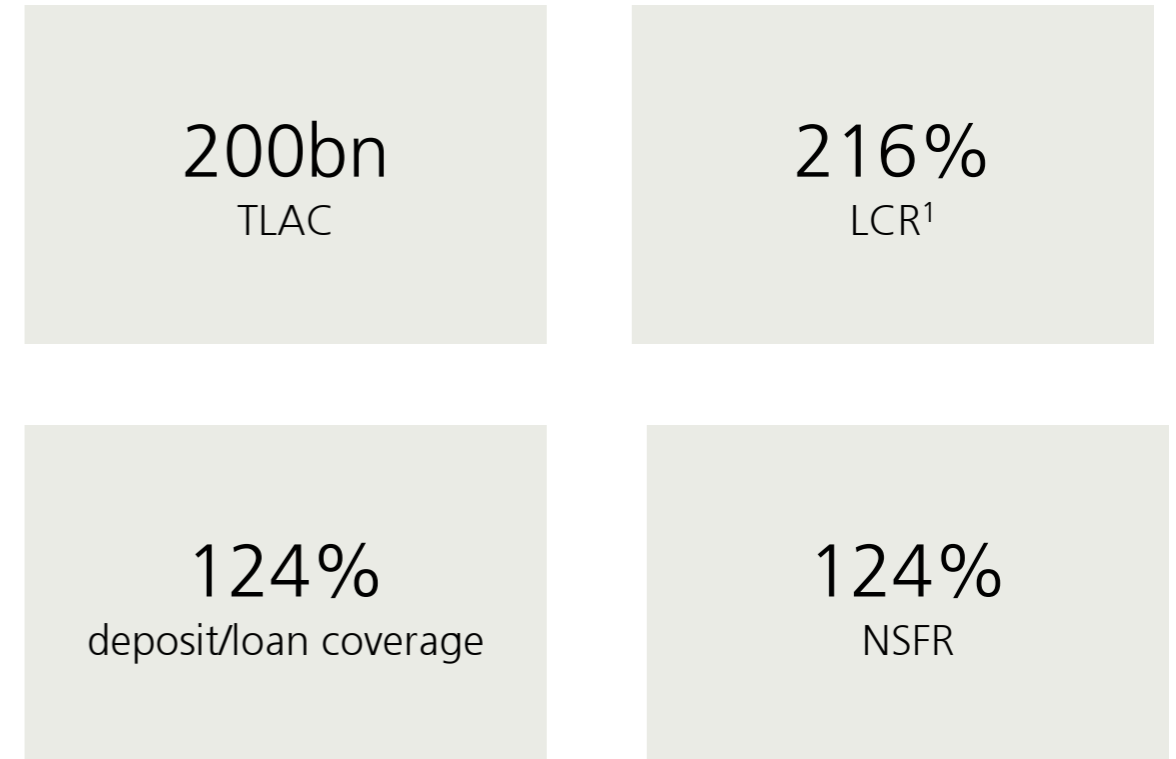

Strong capital position at Group and pro forma combined parent bank level

UBS Group AG capital development 2023-2026 bn, illustrative

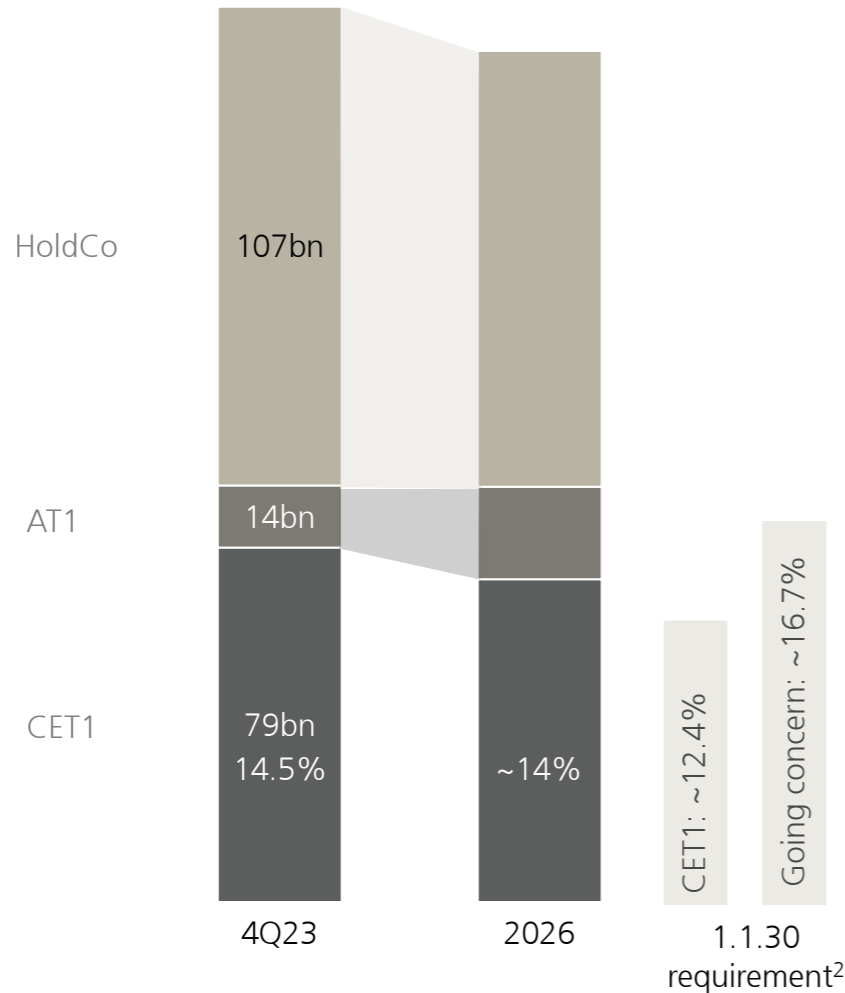

CET1 ratio to remain ~14% while total going concern capital ratio to increase to ~18% by 2029, reflecting gradual build of AT1

Up to 1bn

Funding cost saves, mostly in 2026, from improved funding mix and expected ~10% reduction in HoldCo volumes vs peak 2024 levels¹

UBS AG (standalone) pro forma post-merger

Capital ratios expected to remain above requirements, even without benefit of regulatory filter applied to CS AG

Fully applied³
%

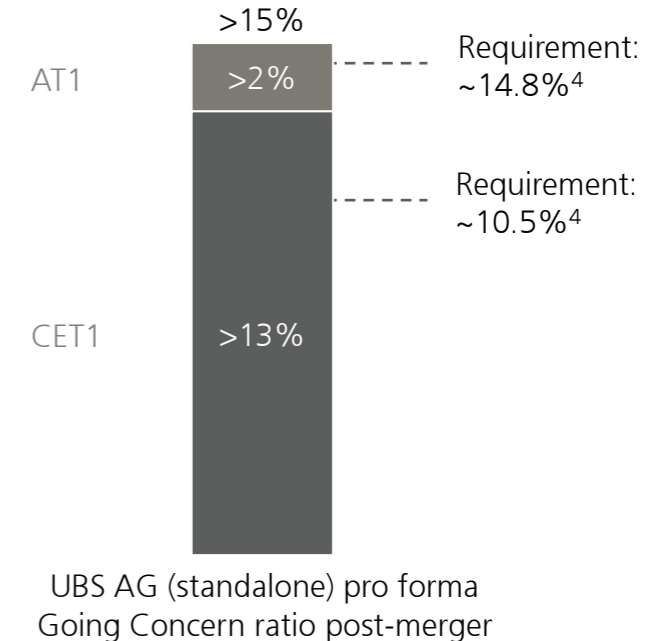

RWA expected to decrease by ~35bn due to optimization and NCL unwind

RWA outlook to 2026

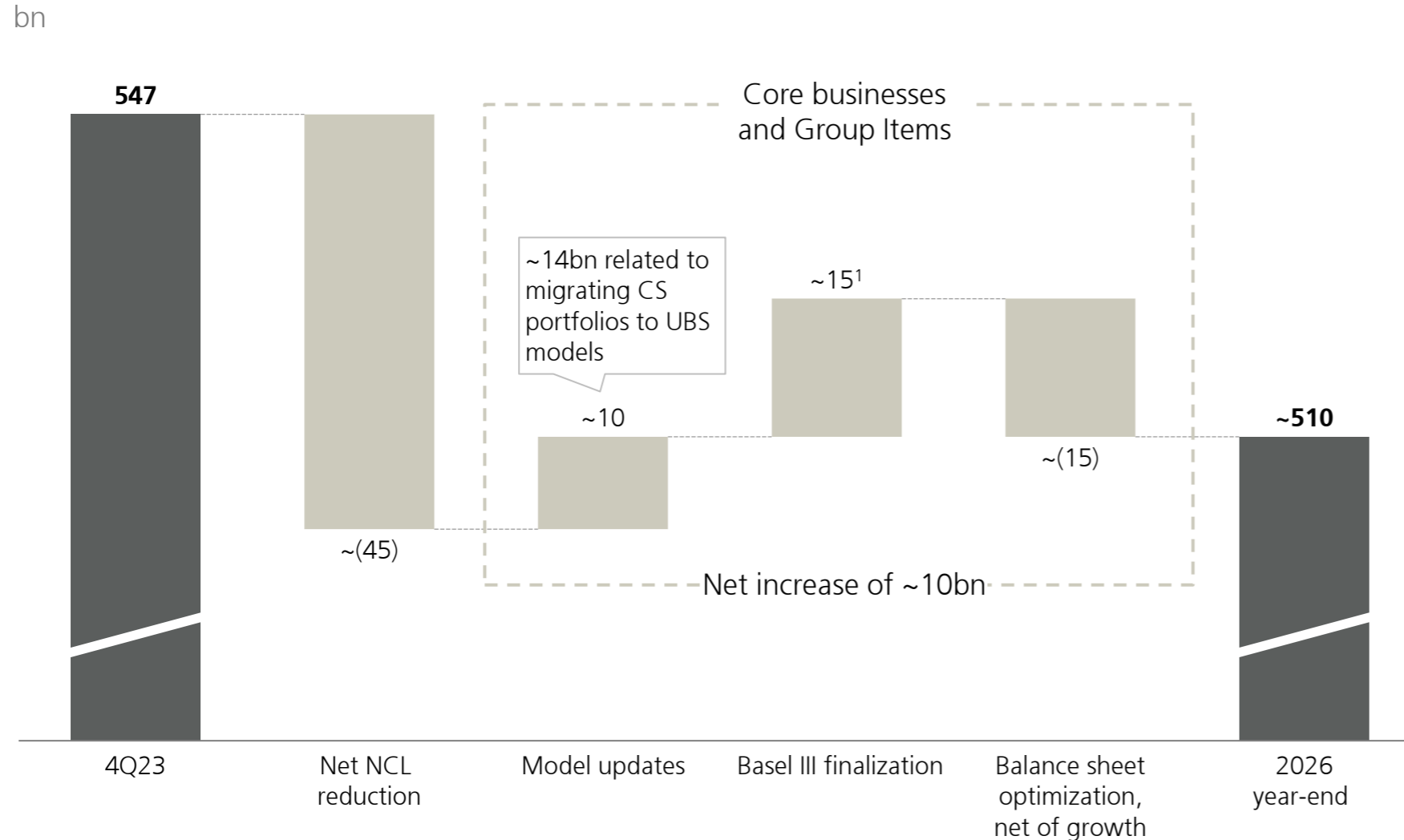

Basel III finalization

Expected 1.1.25; total estimated day-1 impact of ~25bn not reflecting mitigating actions and based on static balance sheet¹

Model updates

Expected in 2024/2025

Allocation changes

~11bn of RWA in Group Items to be pushed out to the business divisions in 1Q; net zero impact on Group

Balance sheet optimization

Disciplined approach to resource consumption

Effective tax rate to reduce following key legal entity mergers

Expected effective tax rate¹

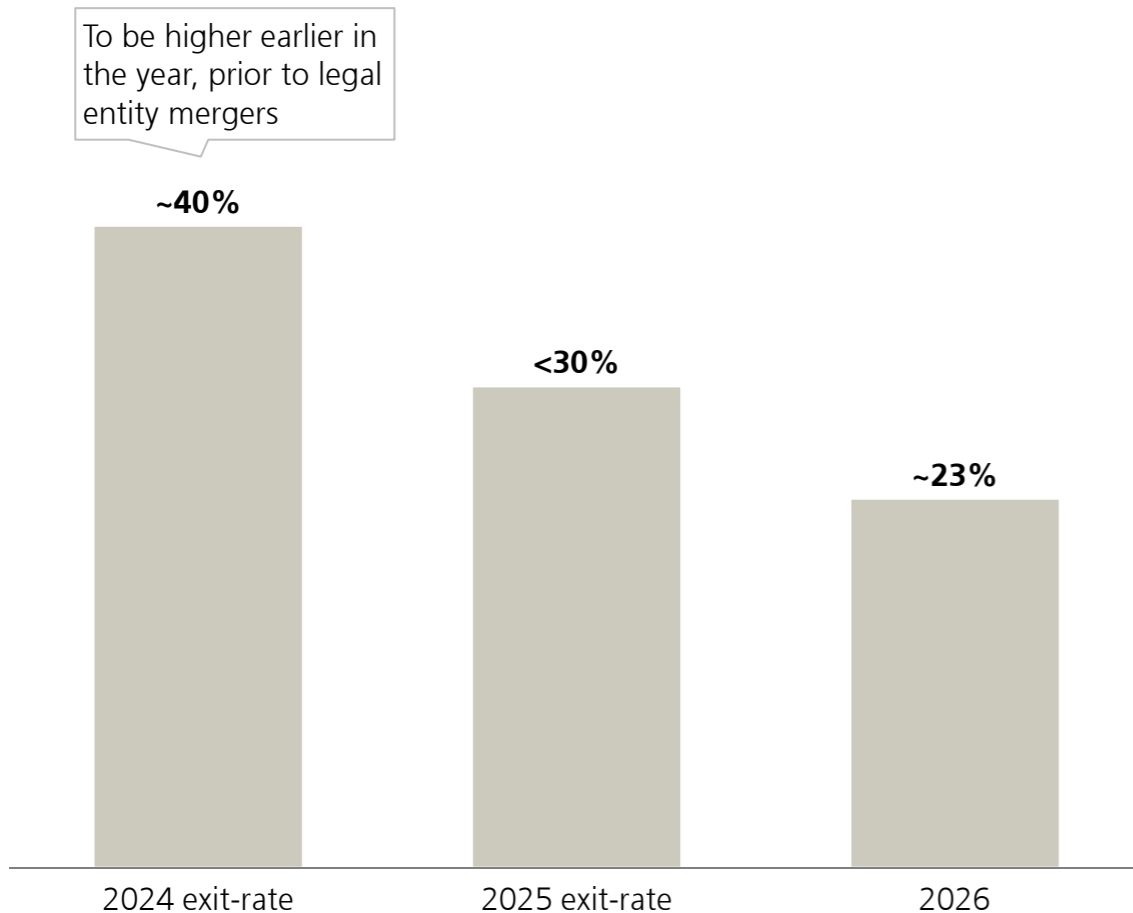

Principal considerations

- 2024 effective tax rate expected to remain elevated, particularly in earlier part of the year, due to stranded losses within Swiss, US and UK entities
- Effective tax rate to reduce as legal entities are consolidated and losses become usable to offset profits, while stranded losses decline
- Further optimization to drive effective tax rate towards more normalized levels in 2025-2026
- ~3bn in tax loss DTAs, of which ~0.5bn expected to amortize and ~2.0bn expected to convert to temporary difference DTA by end-2025

Delivering on our priorities while creating long-term sustainable value

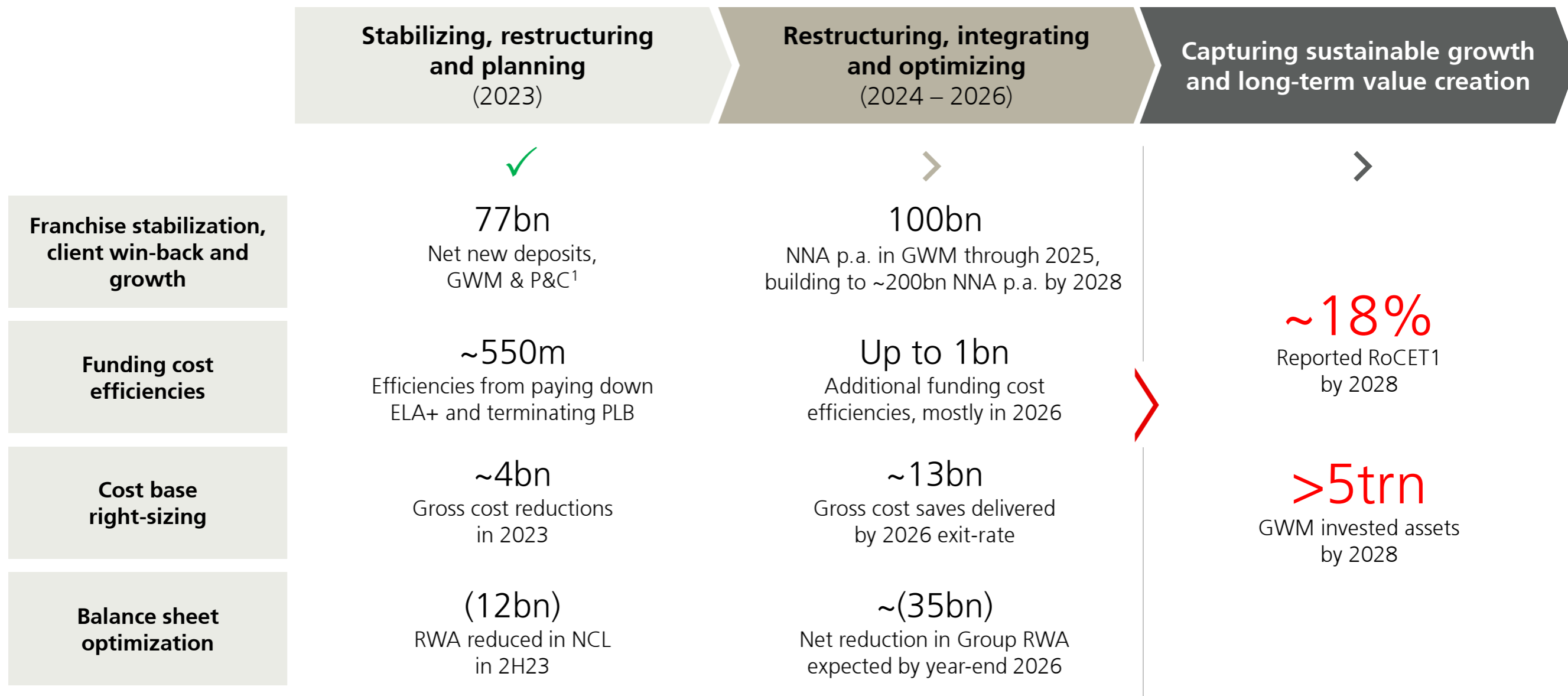

| Appendix

Our financial targets and long-term ambitions

Financial targets

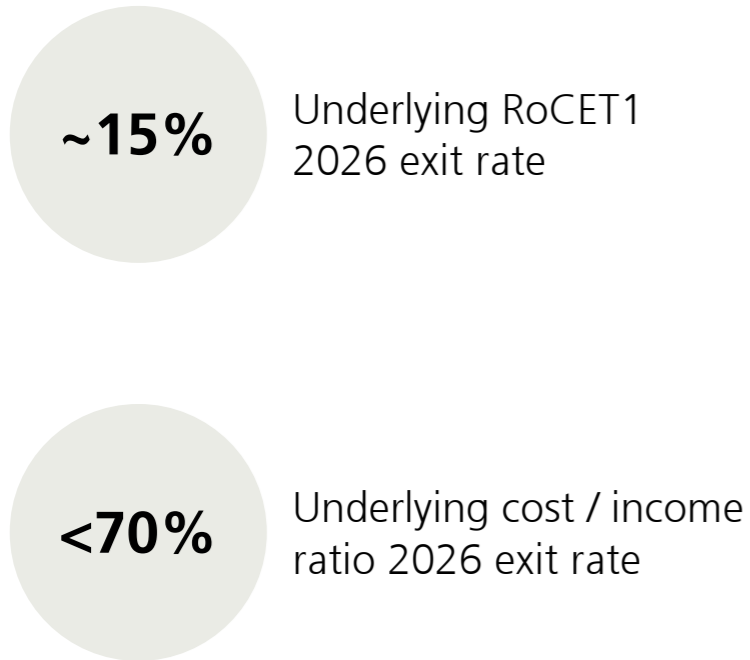

Capital guidance

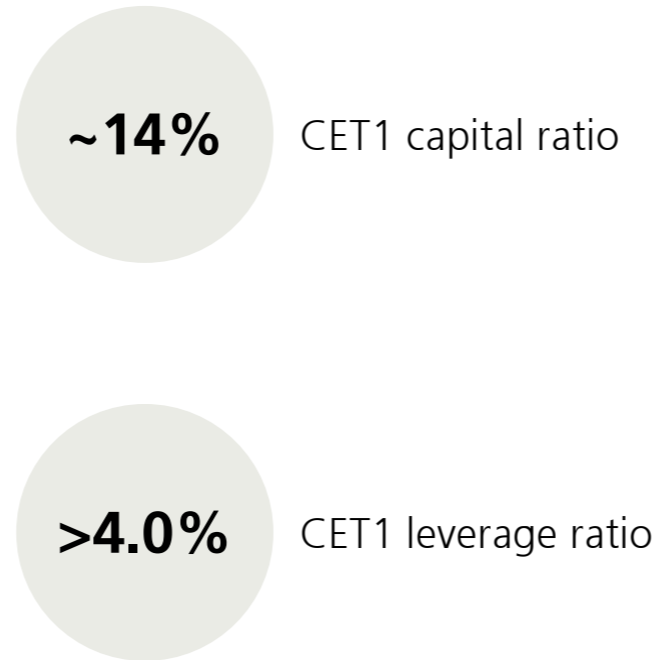

Ambitions long-term

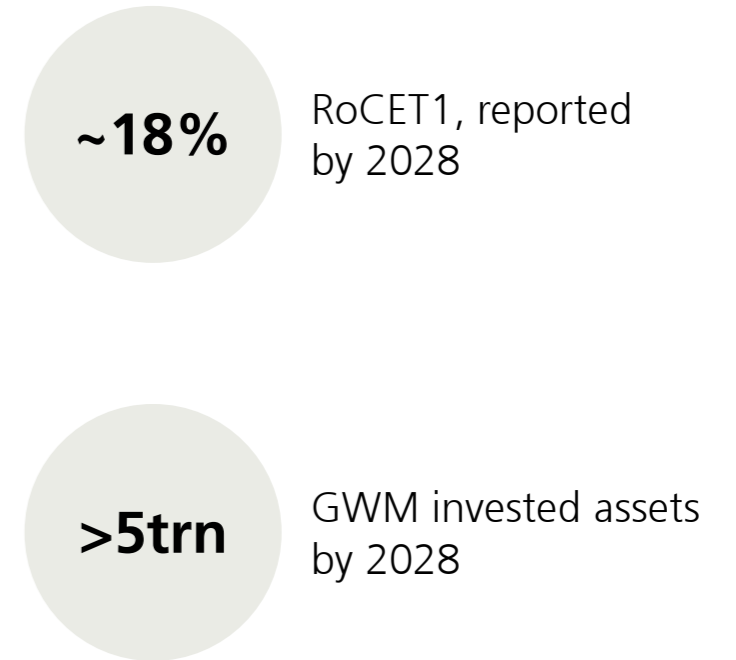

UBS Group results

USD m, except where indicated

	4Q23	3Q23	2Q23	FY23	FY22
Total revenues	10,855	11,695	9,540	40,834	34,563
Negative goodwill			28,925	28,925	
Credit loss expense / (release)	136	239	623	1,037	29
Operating expenses	11,470	11,640	8,486	38,806	24,930
Operating profit / (loss) before tax	(751)	(184)	29,356	29,916	9,604
Tax expense / (benefit)	(473)	526	361	873	1,942
of which: current tax expense	69	643	368	1,567	1,448
Net profit / (loss) attributable to shareholders	(279)	(715)	28,992	29,027	7,630
Diluted EPS (USD)	(0.09)	(0.22)	9.02	8.81	2.25
Effective tax rate	n.m. ¹	n.m. ¹	1.2%	2.9%	20.2%
Return on CET1 capital	(1.4%)	(3.6%)	185.8%	43.7%	17.0%
Return on tangible equity	(1.4%)	(3.6%)	178.4%	42.6%	14.9%
Cost / income ratio	105.7%	99.5%	88.9%	95.0%	72.1%
Total book value per share (USD)	27.20	26.27	26.99	27.20	18.30
Tangible book value per share (USD)	24.86	23.96	24.64	24.86	16.28
Tangible book value per share (CHF)	20.92	21.94	22.08	20.92	15.05

UBS Group 4Q23 underlying results

USD m, except where indicated

	UBS Group AG	GWM	P&C	AM	IB	NCL	Group Items
Operating profit / (loss) before tax as reported	(751)	381	788	115	(169)	(1,726)	(140)
o/w: Pull to par and other PPA effects	944	284	414		277		(32)
o/w: Losses related to investment in SIX Group	(508)	(190)	(317)				
o/w: Integration-related expenses	(1,751)	(490)	(188)	(66)	(166)	(749)	(93)
o/w: Acquisition-related costs	1						1
o/w: Amortization from newly recognized intangibles resulting from the Credit Suisse acquisition	(29)		(29)				
Operating profit / (loss) before tax (underlying)	592	778	908	180	(280)	(977)	(17)
Underlying							
RoCET1	4.7%						
RoTE	4.7%						
Cost / income ratio	93.0%						

UBS Group FY23 underlying results

USD m, except where indicated

	UBS Group AG	GWM	P&C	AM	IB	NCL	Group Items	Negative goodwill
Operating profit / (loss) before tax as reported	29,916	3,589	3,148	318	(44)	(4,741)	(1,279)	28,925
o/w: Negative goodwill	28,925							28,925
o/w: Pull to par and other PPA effects	2,280	719	1,013		583		(35)	
o/w: Losses related to investment in SIX Group	(508)	(190)	(317)					
o/w: Integration-related expenses	(4,478)	(988)	(383)	(205)	(692)	(1,772)	(438)	
o/w: Acquisition-related costs	(202)						(202)	
o/w: Amortization from newly recognized intangibles resulting from the Credit Suisse acquisition	(65)		(65)					
Operating profit / (loss) before tax (underlying)	3,963	4,048	2,902	522	64	(2,969)	(603)	
Underlying								
RoCET1	4.1%							
RoTE	4.0%							
Cost / income ratio	87.2%							

PPA pull to par overview and revenue recognition

Accretion of PPA adjustments on financial instruments

USD bn	Opening balance as of 12.6.23 (close)	Recognized			Estimated amortization profile ⁵			
		2023	Remaining balance to be recognized ⁴	Expected future P&L releases at Year End FX rates	2024	2025	2026	2027+
GWM	~1.5	(0.5)	~1.0	~1.1	(~0.4)	(~0.3)	(~0.2)	(~0.2)
P&C	~4.8	(0.9)	~3.9	~4.3	(~1.0)	(~0.9)	(~0.7)	(~1.7)
IB	~2.1 ²	(0.6)	~1.4	~1.4	(~0.4)	(~0.4)	(~0.3)	(~0.3)
Group Items	~0.9	0.1	~1.0	~1.0	(~0.1)	(~0.1)	(~0.2)	(~0.6)
Total¹	~9.3³	(1.8)	~7.4	~7.8	(~1.9)	(~1.7)	(~1.4)	(~2.8)

(1.3bn) from standard accretion and (0.5bn) from early unwinds

Additional PPA related benefits

USD bn	NII expected to be recognized as of 12.6.23 (close)	Recognized			Estimated amortization profile ⁵			
		2023	Remaining NII expected to be recognized	Expected future P&L releases at Year End FX rates	2024	2025	2026	2027+
Elimination of CS's prior cash flow hedge	~1.2	(0.5)	~0.7	~0.7	(~0.4)	(~0.2)	(~0.1)	(~0.0)

~0.5bn in GWM and ~0.2bn in P&C



1 Excluding Non-core and Legacy, which is not excluded from underlying as the majority of Non-core and Legacy's assets are held at fair value; **2** Opening balance adjusted for Non-core and Legacy perimeter finalization in 3Q23; **3** Excluding ~3.1bn related to assets in Non-core and Legacy, a majority of which have been reclassified to fair value; **4** Represented at acquisition date FX rates; **5** Does not include effects from accelerated accretion from early unwinds

CET1 capital, RWA and LRD

CET1 capital

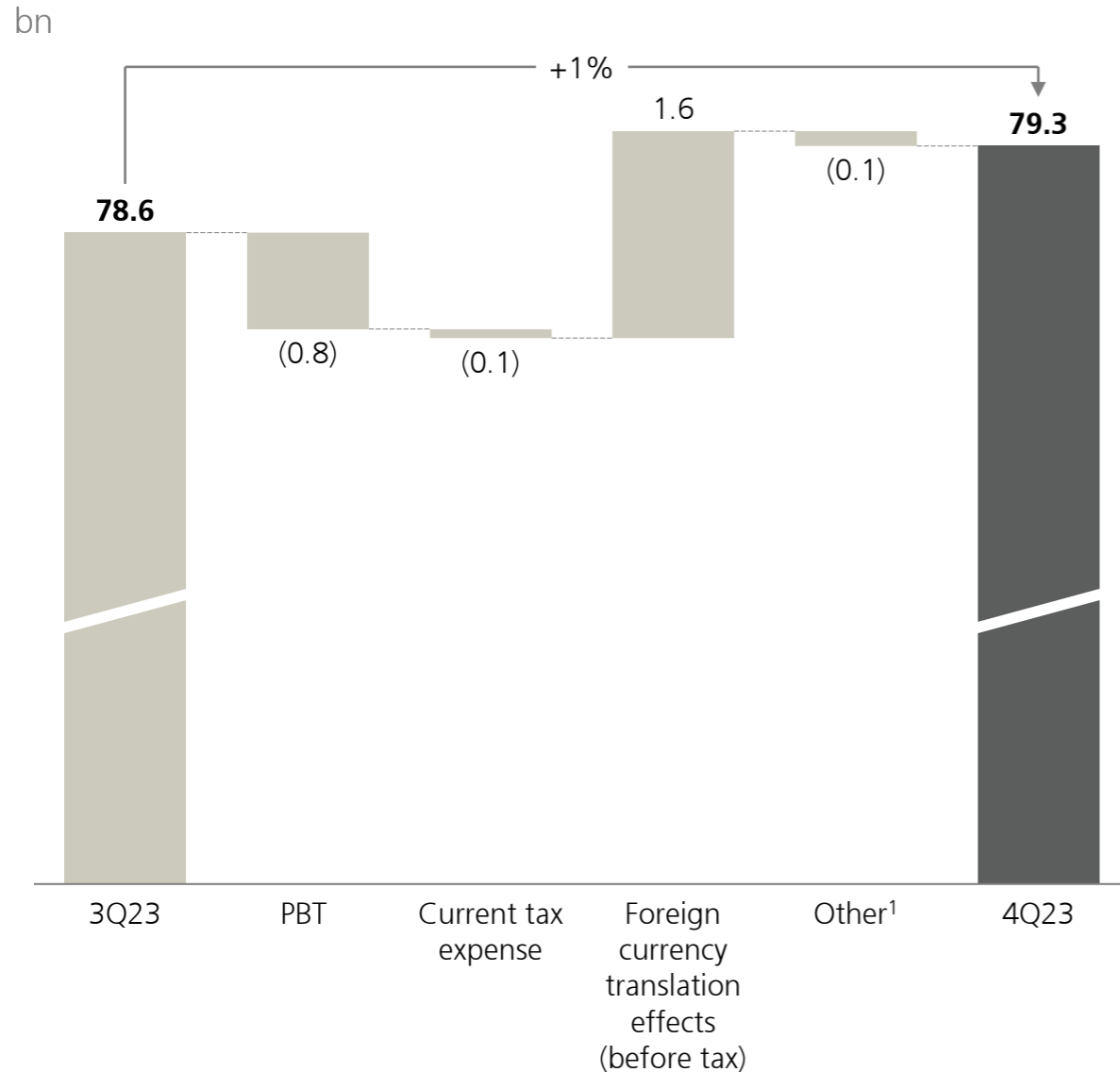

Risk weighted assets

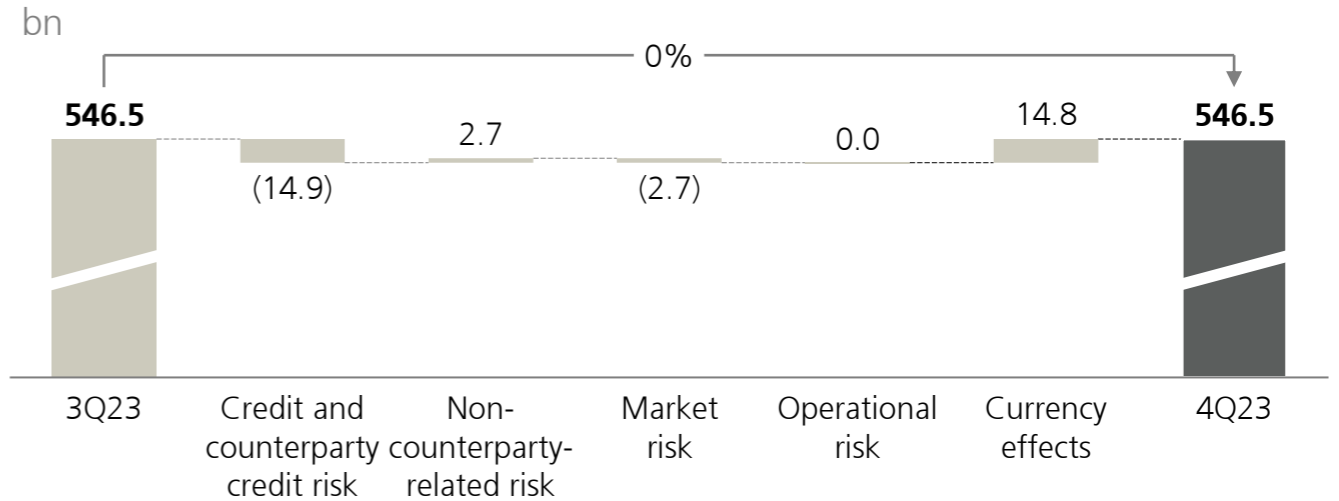

Leverage ratio denominator

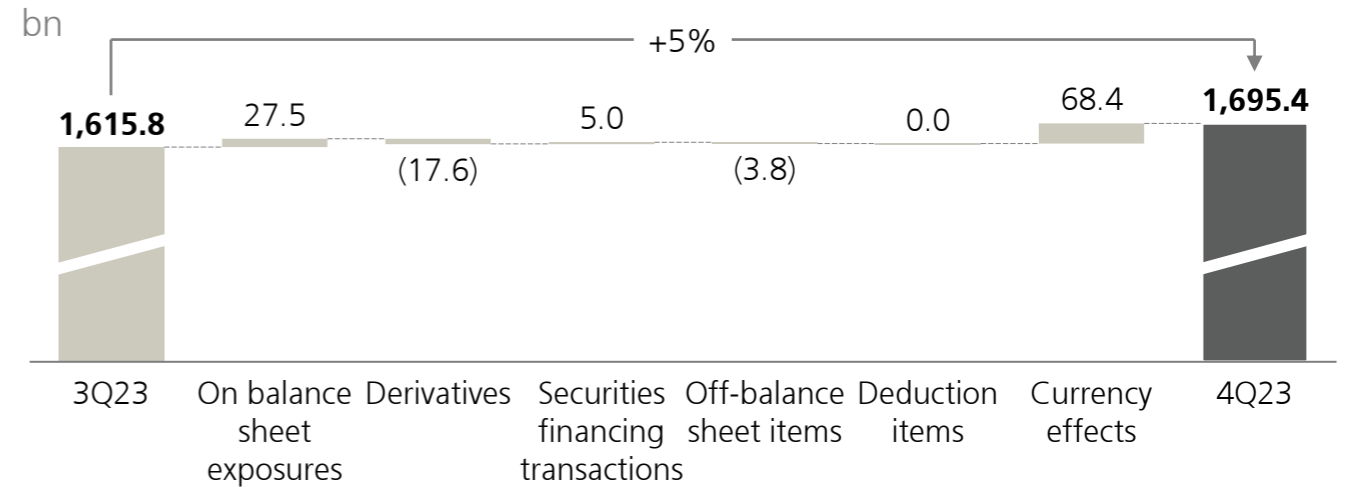

Capital and leverage ratios

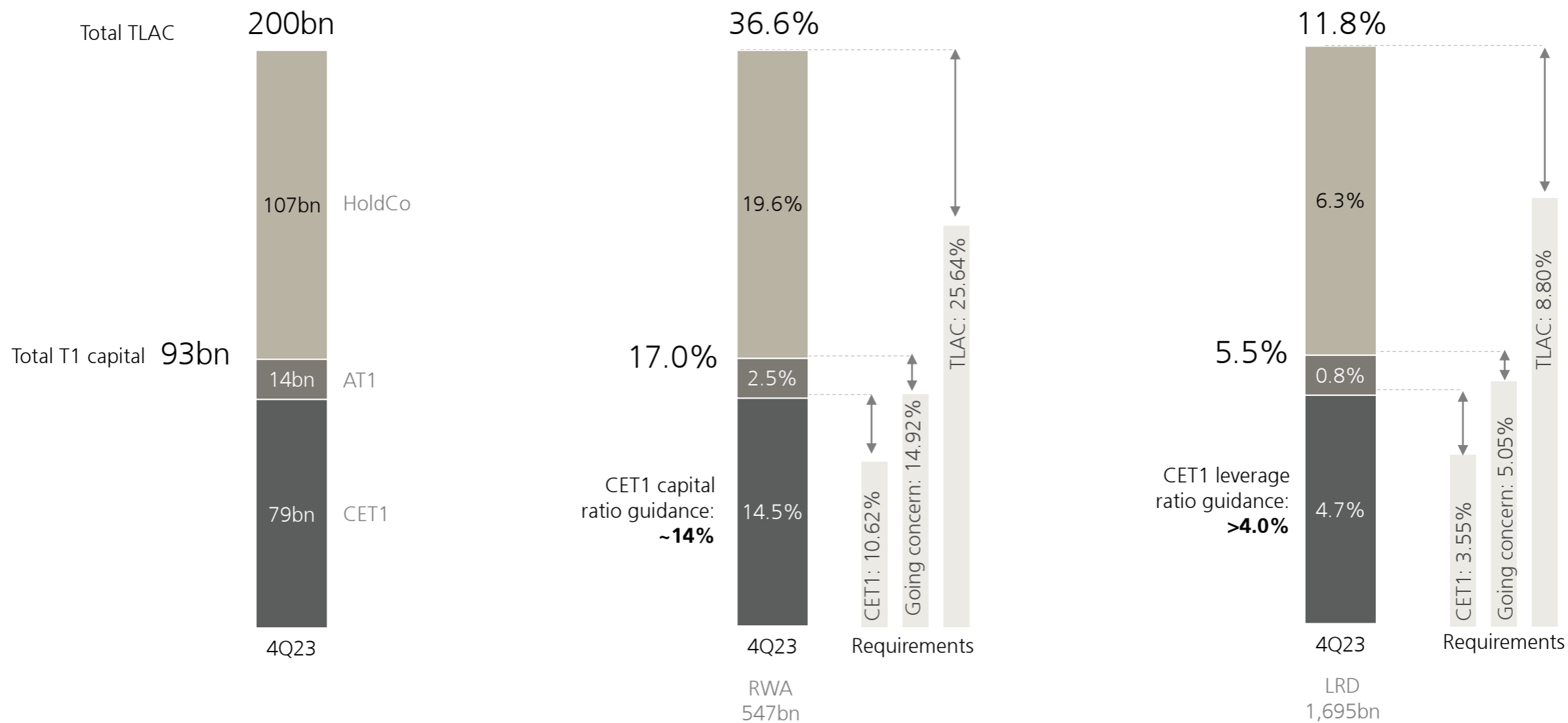

Invested asset split

Global Wealth Management 4Q23

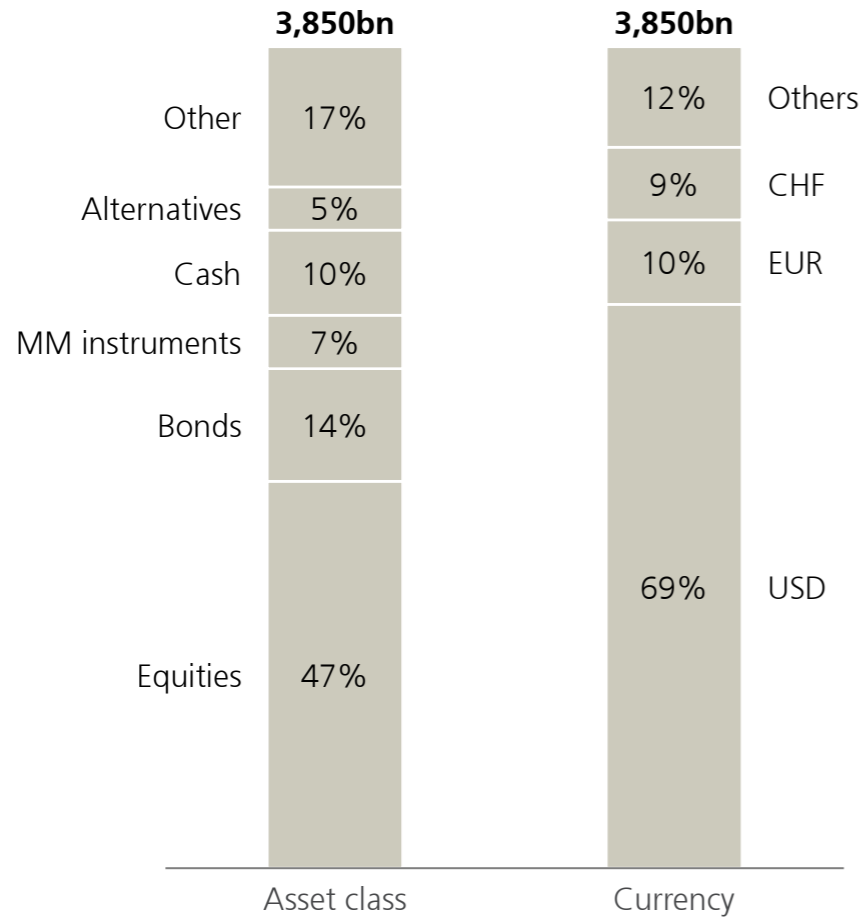

Asset Management 4Q23

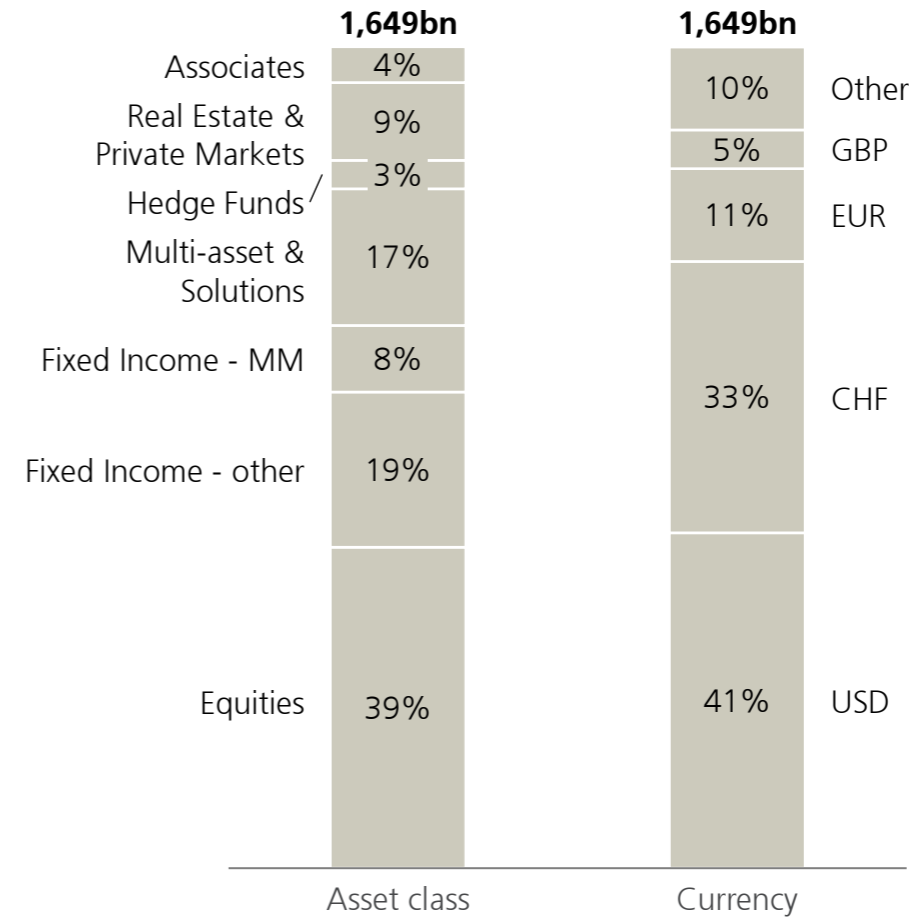

Revenue and expense currency mix

Total revenues¹

%

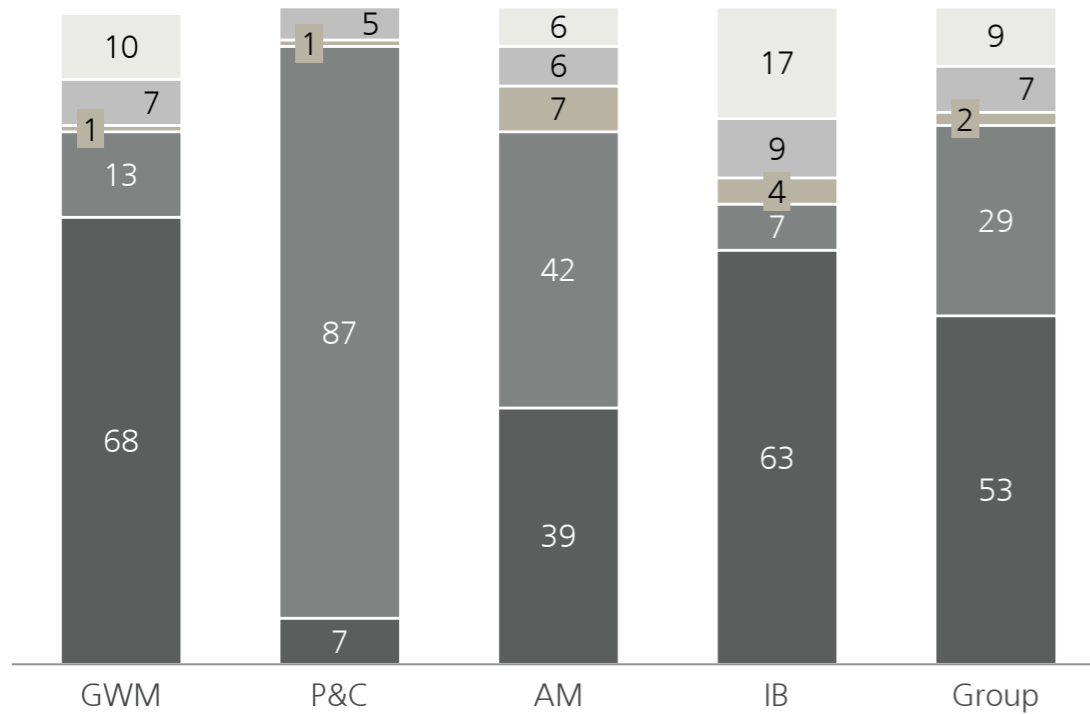

Operating expenses¹

%

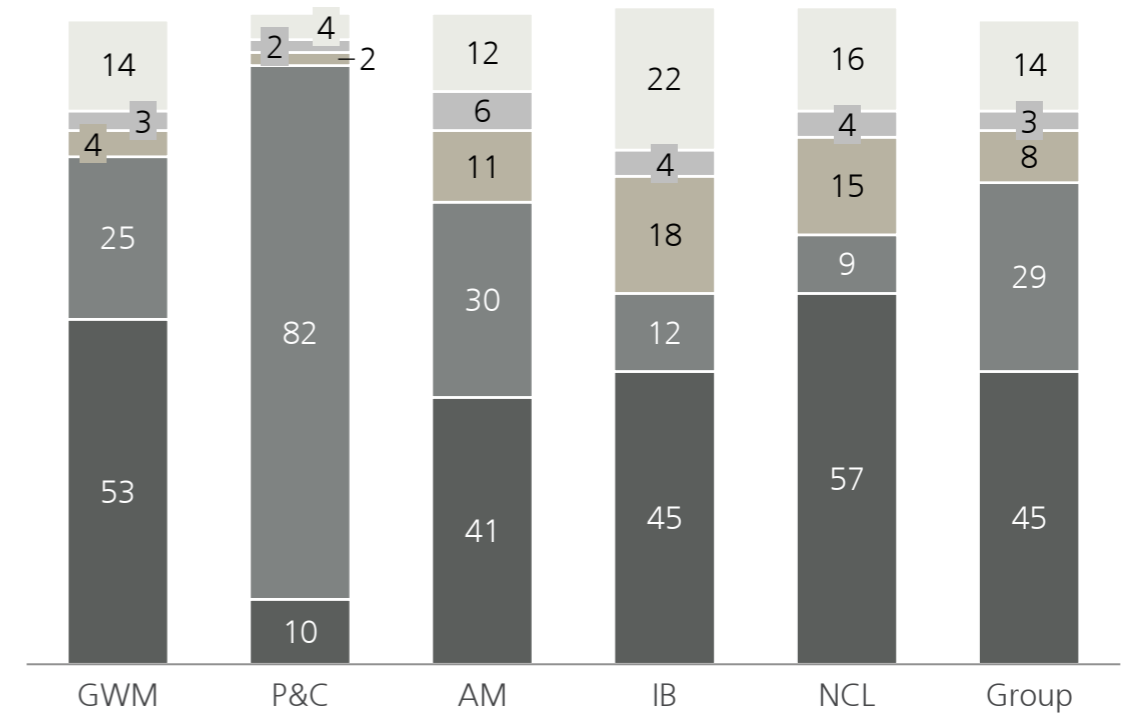

USD
 CHF
 GBP
 EUR
 Other

Select planned legal entity changes (simplified)

UBS Group AG

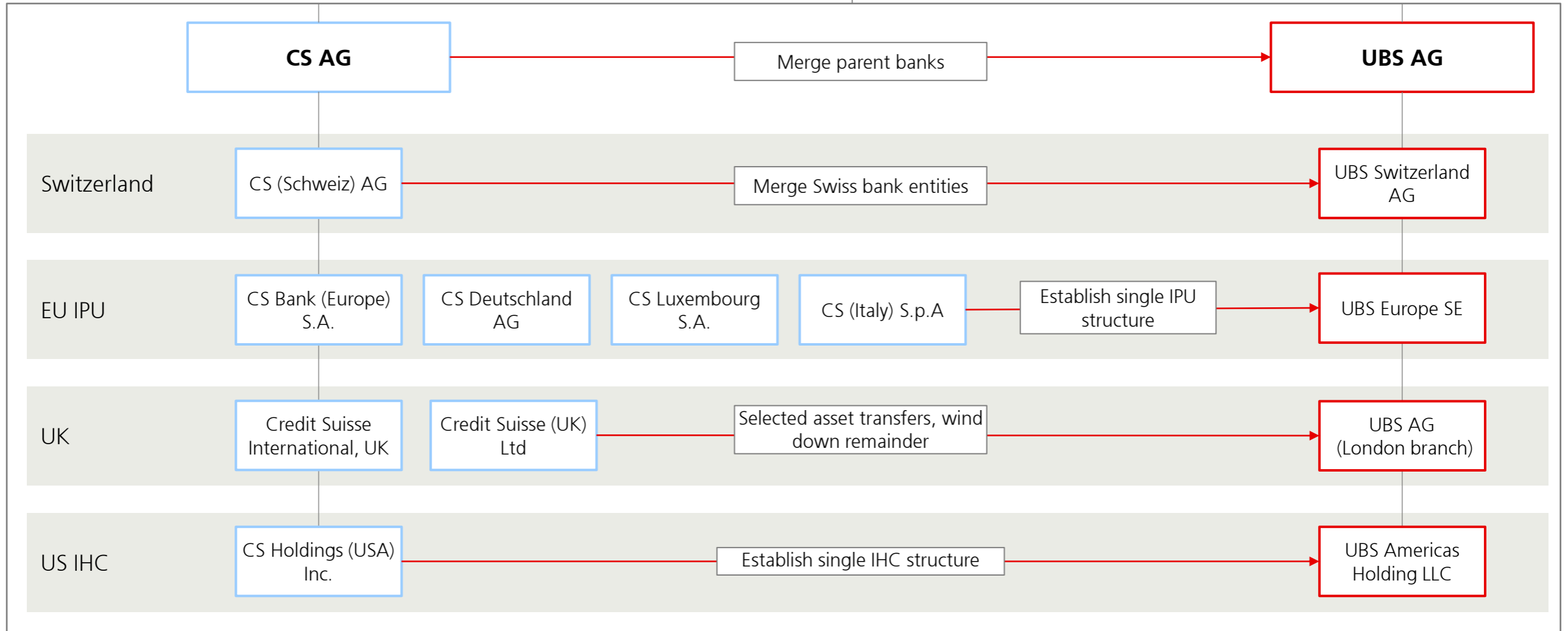

Cautionary statement regarding Forward looking statements

Cautionary Statement Regarding Forward looking Statements | This presentation contains statements that constitute “forward-looking statements,” including but not limited to management’s outlook for UBS’s financial performance, statements relating to the anticipated effect of transactions and strategic initiatives on UBS’s business and future development and goals or intentions to achieve climate, sustainability and other social objectives. While these forward-looking statements represent UBS’s judgments, expectations and objectives concerning the matters described, a number of risks, uncertainties and other important factors could cause actual developments and results to differ materially from UBS’s expectations. In particular, terrorist activity and conflicts in the Middle East, as well as the continuing Russia–Ukraine war, may have significant impacts on global markets, exacerbate global inflationary pressures, and slow global growth. In addition, the ongoing conflicts may continue to cause significant population displacement, and lead to shortages of vital commodities, including energy shortages and food insecurity outside the areas immediately involved in armed conflict. Governmental responses to the armed conflicts, including, with respect to the Russia–Ukraine war, coordinated successive sets of sanctions on Russia and Belarus, and Russian and Belarusian entities and nationals, and the uncertainty as to whether the ongoing conflicts will widen and intensify, may continue to have significant adverse effects on the market and macroeconomic conditions, including in ways that cannot be anticipated. UBS’s acquisition of the Credit Suisse Group has materially changed our outlook and strategic direction and introduced new operational challenges. The integration of the Credit Suisse entities into the UBS structure is expected to take between three and five years and presents significant risks, including the risks that UBS Group AG may be unable to achieve the cost reductions and other benefits contemplated by the transaction. This creates significantly greater uncertainty about forward-looking statements. Other factors that may affect our performance and ability to achieve our plans, outlook and other objectives also include, but are not limited to: (i) the degree to which UBS is successful in the execution of its strategic plans, including its cost reduction and efficiency initiatives and its ability to manage its levels of risk-weighted assets (RWA) and leverage ratio denominator (LRD), liquidity coverage ratio and other financial resources, including changes in RWA assets and liabilities arising from higher market volatility and the size of the combined Group; (ii) the degree to which UBS is successful in implementing changes to its businesses to meet changing market, regulatory and other conditions, including as a result of the acquisition of the Credit Suisse Group; (iii) increased inflation and interest rate volatility in major markets; (iv) developments in the macroeconomic climate and in the markets in which UBS operates or to which it is exposed, including movements in securities prices or liquidity, credit spreads, currency exchange rates, deterioration or slow recovery in residential and commercial real estate markets, the effects of economic conditions, including increasing inflationary pressures, market developments, increasing geopolitical tensions, and changes to national trade policies on the financial position or creditworthiness of UBS’s clients and counterparties, as well as on client sentiment and levels of activity; (v) changes in the availability of capital and funding, including any adverse changes in UBS’s credit spreads and credit ratings of UBS, Credit Suisse, sovereign issuers, structured credit products or credit-related exposures, as well as availability and cost of funding to meet requirements for debt eligible for total loss-absorbing capacity (TLAC), in particular in light of the acquisition of the Credit Suisse Group; (vi) changes in central bank policies or the implementation of financial legislation and regulation in Switzerland, the US, the UK, the EU and other financial centers that have imposed, or resulted in, or may do so in the future, more stringent or entity-specific capital, TLAC, leverage ratio, net stable funding ratio, liquidity and funding requirements, heightened operational resilience requirements, incremental tax requirements, additional levies, limitations on permitted activities, constraints on remuneration, constraints on transfers of capital and liquidity and sharing of operational costs across the Group or other measures, and the effect these will or would have on UBS’s business activities; (vii) UBS’s ability to successfully implement resolvability and related regulatory requirements and the potential need to make further changes to the legal structure or booking model of UBS in response to legal and regulatory requirements and any additional requirements due to its acquisition of the Credit Suisse Group, or other developments; (viii) UBS’s ability to maintain and improve its systems and controls for complying with sanctions in a timely manner and for the detection and prevention of money laundering to meet evolving regulatory requirements and expectations, in particular in current geopolitical turmoil; (ix) the uncertainty arising from domestic stresses in certain major economies; (x) changes in UBS’s competitive position, including whether differences in regulatory capital and other requirements among the major financial centers adversely affect UBS’s ability to compete in certain lines of business; (xi) changes in the standards of conduct applicable to our businesses that may result from new regulations or new enforcement of existing standards, including measures to impose new and enhanced duties when interacting with customers and in the execution and handling of customer transactions; (xii) the liability to which UBS may be exposed, or possible constraints or sanctions that regulatory authorities might impose on UBS, due to litigation, contractual claims and regulatory investigations, including the potential for disqualification from certain businesses, potentially large fines or monetary penalties, or the loss of licenses or privileges as a result of regulatory or other governmental sanctions, as well as the effect that litigation, regulatory and similar matters have on the operational risk component of our RWA, including as a result of its acquisition of the Credit Suisse Group, as well as the amount of capital available for return to shareholders; (xiii) the effects on UBS’s business, in particular cross-border banking, of sanctions, tax or regulatory developments and of possible changes in UBS’s policies and practices; (xiv) UBS’s ability to retain and attract the employees necessary to generate revenues and to manage, support and control its businesses, which may be affected by competitive factors; (xv) changes in accounting or tax standards or policies, and determinations or interpretations affecting the recognition of gain or loss, the valuation of goodwill, the recognition of deferred tax assets and other matters; (xvi) UBS’s ability to implement new technologies and business methods, including digital services and technologies, and ability to successfully compete with both existing and new financial service providers, some of which may not be regulated to the same extent; (xvii) limitations on the effectiveness of UBS’s internal processes for risk management, risk control, measurement and modeling, and of financial models generally; (xviii) the occurrence of operational failures, such as fraud, misconduct, unauthorized trading, financial crime, cyberattacks, data leakage and systems failures, the risk of which is increased with cyberattack threats from both nation states and non-nation-state actors targeting financial institutions; (xix) restrictions on the ability of UBS Group AG to make payments or distributions, including due to restrictions on the ability of its subsidiaries to make loans or distributions, directly or indirectly, or, in the case of financial difficulties, due to the exercise by FINMA or the regulators of UBS’s operations in other countries of their broad statutory powers in relation to protective measures, restructuring and liquidation proceedings; (xx) the degree to which changes in regulation, capital or legal structure, financial results or other factors may affect UBS’s ability to maintain its stated capital return objective; (xxi) uncertainty over the scope of actions that may be required by UBS, governments and others for UBS to achieve goals relating to climate, environmental and social matters, as well as the evolving nature of underlying science and industry and the possibility of conflict between different governmental standards and regulatory regimes; (xxii) the ability of UBS to access capital markets; (xxiii) the ability of UBS to successfully recover from a disaster or other business continuity problem due to a hurricane, flood, earthquake, terrorist attack, war, conflict (e.g., the Russia–Ukraine war), pandemic, security breach, cyberattack, power loss, telecommunications failure or other natural or man-made event, including the ability to function remotely during long-term disruptions such as the COVID-19 (coronavirus) pandemic; (xxiv) the level of success in the absorption of Credit Suisse, in the integration of the two groups and their businesses, and in the execution of the planned strategy regarding cost reduction and divestment of any non-core assets, the existing assets and liabilities of Credit Suisse, the level of resulting impairments and write-downs, the effect of the consummation of the integration on the operational results, share price and credit rating of UBS – delays, difficulties, or failure in closing the transaction may cause market disruption and challenges for UBS to maintain business, contractual and operational relationships; and (xxv) the effect that these or other factors or unanticipated events, including media reports and speculations, may have on our reputation and the additional consequences that this may have on our business and performance. The sequence in which the factors above are presented is not indicative of their likelihood of occurrence or the potential magnitude of their consequences. Our business and financial performance could be affected by other factors identified in our past and future filings and reports, including those filed with the US Securities and Exchange Commission (the SEC). More detailed information about those factors is set forth in documents furnished by UBS and filings made by UBS with the SEC, including the Risk Factors filed on Form 6-K with the 2Q23 UBS Group AG report on 31 August 2023 and the Annual Report on Form 20-F for the year ended 31 December 2022. UBS is not under any obligation to (and expressly disclaims any obligation to) update or alter its forward-looking statements, whether as a result of new information, future events, or otherwise.

© UBS 2024. The key symbol and UBS are among the registered and unregistered trademarks of UBS. All rights reserved